

SKF

# SKF bushings



# Contents

## BUSHING SELECTION

<b>World's Widest Bushing Stock Assortment</b> .....	2
<b>SKF Bushings – Product Guide</b> .....	4
<b>SKF Bushings – Technical Data</b> .....	6
<b>Bushing Selection – Overview of Technical Data</b>	
Temperature range .....	7
Coefficient of friction .....	7
Load capacity .....	8
Sliding velocity .....	8
Shaft recommendations .....	9

## PRODUCT SPECIFIC INFORMATION – TECHNICAL DATA

<b>SKF Solid Bronze</b> – The all-round runner .....	11
<b>SKF Sintered Bronze</b> – The fast runner .....	13
<b>SKF Wrapped Bronze</b> – The cross country runner.....	15
<b>SKF PTFE Composite</b> – The long runner .....	17
<b>SKF POM Composite</b> – The up-hill runner .....	19
<b>SKF Stainless Backed Composite</b> – The smooth & shiny runner .....	21
<b>SKF PTFE Polyamide</b> – The jogging runner .....	23
<b>SKF Filament Wound</b> – The heavy duty runner .....	25

## ASSORTMENT

<b>SKF Solid Bronze</b> – The all-round runner .....	28
<b>SKF Sintered Bronze</b> – The fast runner .....	32
<b>SKF Wrapped Bronze</b> – The cross country runner .....	36
<b>SKF PTFE Composite</b> – The long runner .....	38
<b>SKF POM Composite</b> – The up-hill runner .....	44
<b>SKF Stainless Backed Composite</b> – The smooth & shiny runner.....	48
<b>SKF PTFE Polyamide</b> – The jogging runner .....	50
<b>SKF Filament Wound</b> – The heavy duty runner .....	52

# World's Widest Bushings



## SKF – number one in bearings

Made by SKF® stands for excellence. It symbolises our consistent endeavour to achieve total quality in everything we do. We provide our customers with outstanding bushing quality.

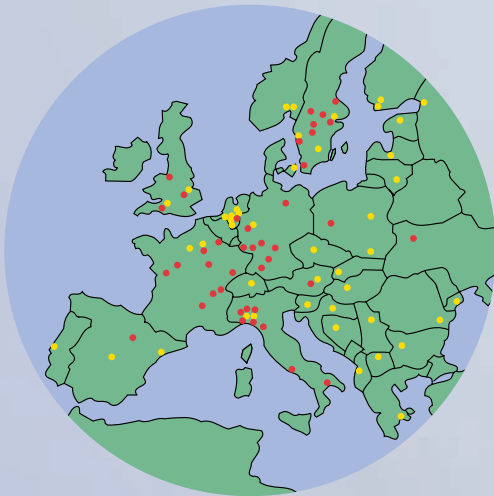

## SKF – your only bushing partner

Using our global sales network and logistics expertise we offer a delivery service level far beyond that of any competitor. With the world's widest bushing stock assortment distributors and end users now have the solution for most industries and application needs from one single source.

	SKF	Solid Bronze The oil-saver	Babbitt Bronze The load-carryer	Wrought Bronze The long-lasting	PTFE Composite The low-friction	PCM Composite The oil-free	Stainless Steel The corrosion-resistant
Self-lubricating performance	-	+	++	-	++	+	++
Maintenance-free operation	+	0	+	++	0	++	+
Dirty environment	+	0	+	++	+	++	+
Corrosion resistant	+	-	0	+	0	++	+
High temperature	0	0	0	+	++	++	++
High load	+	++	0	-	++	0	+
Shock loads/vibrations	-	+	-	-	0	0	0
High sliding velocity	-	-	0	-	++	-	0
Low friction	+	0	0	0	++	-	0
High shaft surface finish	+	0	0	0	++	-	0
Small mounting clearance	+	0	+	+	++	-	0
Sensitive to misalignment	0	+	+	+	++	-	0
Low load	+	+	+	+	++	-	0

## SKF – we help to select the right bushing for you

Throughout the world we are recognised as the leading rolling bearing manufacturer. We are renowned for our excellent technical support and application know-how. However, we are also a major player in the plain bearing field: spherical plain bearings, rod ends and now a much expanded range of bushings. The **new** product selection guide in this catalogue simplifies the selection of bushings from our expanded range for you.

# ng Stock Assortment

## SKF Solid Bronze

### **The all-round runner**

The traditional and robust bushing material

## SKF Sintered Bronze

### **The fast runner**

Oil impregnation allows very high sliding velocity

## SKF Wrapped Bronze

### **The cross country runner**

Excellent in dirty environments due to lubrication pockets

## SKF PTFE Composite

### **The long runner**

Long maintenance-free operating life due to low friction

## SKF POM Composite

### **The up-hill runner**

Optimal combination of low maintenance under tough running conditions

## SKF Stainless Backed Composite

### **The smooth & shiny runner**

The non-corrosive maintenance-free long runner

## SKF PTFE Polyamide

### **The jogging runner**

The cost efficient maintenance-free bushing



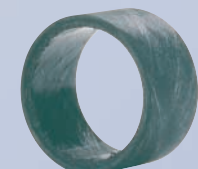
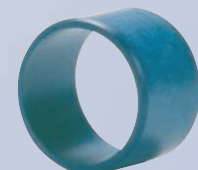
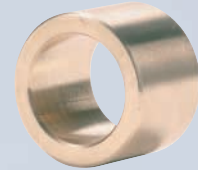

## SKF Filament Wound

### **The heavy duty runner**

The maintenance-free bushing for extreme running conditions

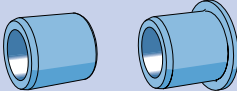
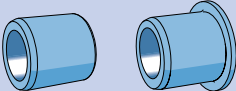
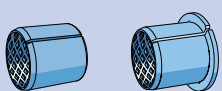

# SKF Bushings –

			
	<b>Solid Bronze</b> The all-round runner	<b>Sintered Bronze</b> The fast runner	<b>Wrapped Bronze</b> The cross country runner
Self-lubricating performance	–	+	–
Maintenance-free operation	–	+	0
Dirty environment	+	0	++
Corrosion resistant	+	0	+
High temperature	+	–	+
High load	0	–	0
Shock loads/vibrations	+	0	+
High sliding velocity	–	++	0
Low friction	–	+	–
Poor shaft surface finish	+	–	0
Small operating clearance	–	0	0
Insensitive to misalignment	+	0	0
Low price level	0	+	+
Assortment			
Product series designation	PBM PBMF	PSM PSMF	PRM PRMF
Page	28	32	36

# Product Guide

				
PTFE Composite The long runner	POM Composite The up-hill runner	Stainless Backed Composite The smooth & shiny runner	PTFE Polyamide The jogging runner	Filament Wound The heavy duty runner
++	+	++	++	++
++	+	++	++	++
-	0	-	-	+
0	0	++	++	++
++	0	+	0	+
+	++	+	0	++
0	0	0	-	++
+	+	+	0	-
++	++	++	0	++
-	0	-	0	0
++	+	+	0	-
-	0	-	0	+
++	++	-	++	-
				
PCM .. E(B) PCMW .. B PCMF .. E(B) PCMS .. B	PCM .. M PCMW .. M PCMS .. M	PI	PPM PPMF	PWM
38	44	48	50	52

Suitable (0)

Not suitable (-)

# SKF Bushings – Technical Data

										
		<b>Solid Bronze</b> The all-round runner	<b>Sintered Bronze</b> The fast runner	<b>Wrapped Bronze</b> The cross country runner	<b>PTFE Composite</b> The long runner	<b>POM Composite</b> The up-hill runner	<b>Stainless Backed Composite</b> The smooth & shiny runner	<b>PTFE Polyamide</b> The jogging runner	<b>Filament Wound</b> The heavy duty runner	
Temperature range, °C		-40 .. +250	-10 .. +90	-40 .. +150	-200 .. +250	-40 .. +110	-150 .. +150	-30 .. +110	-50 .. +140	
Friction coefficient, $\mu$		0,08 .. 0,15	0,05 .. 0,10	0,08 .. 0,15	0,03 .. 0,25	0,04 .. 0,12	0,03 .. 0,17	0,06 .. 0,15	0,03 .. 0,08	
Permissible load, N/mm <sup>2</sup> – dynamic – static		25 45	10 20	40 120	80 ( $v \leq 0,02$ ) 250	120 ( $v \leq 0,02$ ) 250	80 ( $v \leq 0,5$ ) 300	40 80	140 200	
Permissible sliding velocity, m/s		0,5	0,25 .. 5	1,0	2,0 ( $p \leq 1,0$ )	2,0 ( $p \leq 1,0$ )	1,5	1,0	0,5	
Shaft tolerance		e7 – e8	f7 – f8	e7 – f8	f7 – h8	h7 – h8	g6 – f7	h8 – h9	h7 – h8	
Housing tolerance		H7	H7	H7	H7	H7	H7	H7	H7	
Shaft roughness $R_a$ , $\mu\text{m}$		0 .. 1,0	0,2 .. 0,8	0,4 .. 0,8	0 .. 0,4	0 .. 0,8	0 .. 0,4	0 .. 0,8	0 .. 0,8	
Shaft hardness, HB		165 – 400	200 – 300	150 – 400	300 – 600	150 – 600	300 – 600	100 – 300	200 – 600	
Assortment										
Product series designation		PBM	PSM	PRM	PCMF..E(B) PCMW..B PCMS..B	PCM..M PCMW..M PCMS..M	PI	PPM	PPMF	PWM

The sliding velocity can be calculated using

$$v = n \times \pi \times d / (60 \times 1\,000)$$

where

v = sliding velocity, m/s  
n = rotational speed, r/min  
d = bore diameter of bushing, mm

The specific bearing load can be calculated using

$$p = F / (d \times b)$$

where

p = specific bearing load, N/mm<sup>2</sup>  
F = bearing load, N  
d = bore diameter of bushing, mm  
b = width of bushing, mm

# Bushing Selection

## Overview of Technical Data

### Temperature range

Ambient temperature range (°C) for the different SKF sliding materials under normal operating conditions.

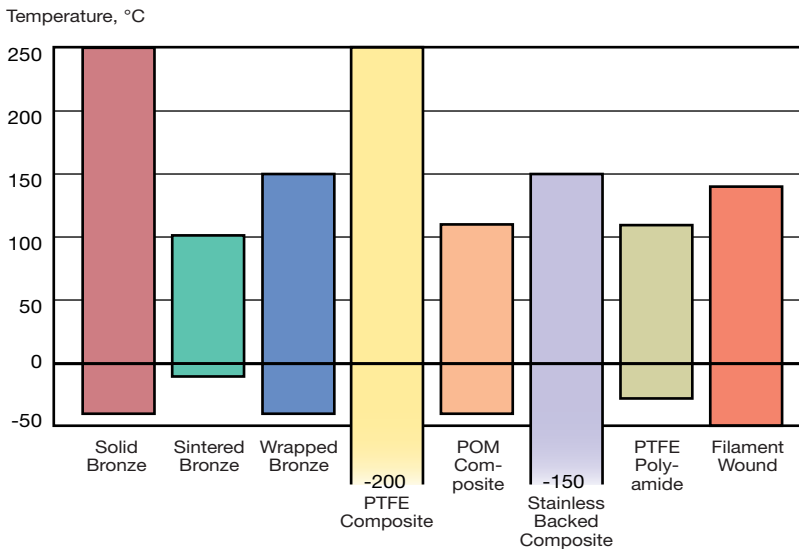

The temperature range for SKF Solid and Wrapped Bronze bushings can be extended by using special lubricant.

### Coefficient of friction

Coefficient of friction ( $\mu$ ) under dry or initially lubricated operating conditions (typical values) for the different SKF sliding materials.

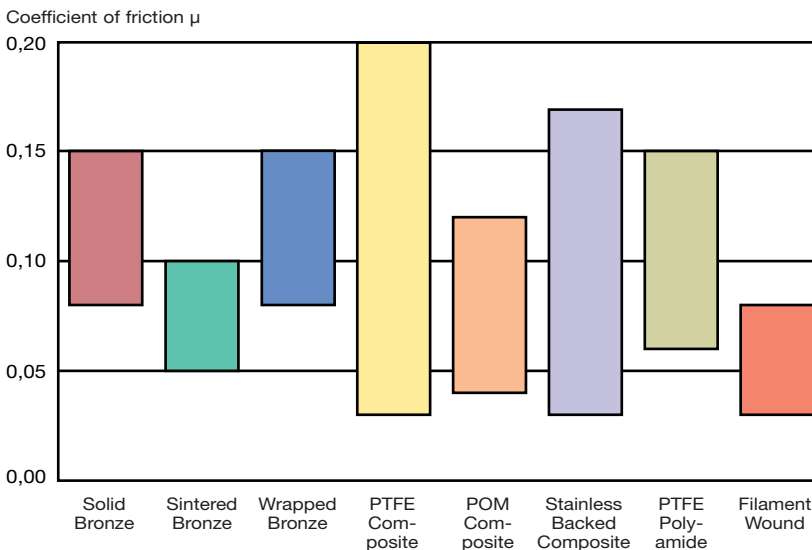

The friction of SKF sliding materials against a technical surface depends principally on the load, sliding velocity, surface roughness of the mating surface and the lubrication conditions. The lower coefficients of friction are obtained under high specific loads at low sliding velocities (not applicable to SKF Sintered Bronze).

Both higher and lower friction can occur under extreme conditions.



The load capacity for a specific application also depends on several other factors, such as type of load, sliding velocity and frequency of oscillation.

### Load capacity

Permissible specific bearing load,  $p$  (dynamic),  $N/mm^2$ , at a sliding velocity less than 0,01 m/s and permissible static load ( $N/mm^2$ ) at  $v = 0$  m/s for the different SKF sliding materials.

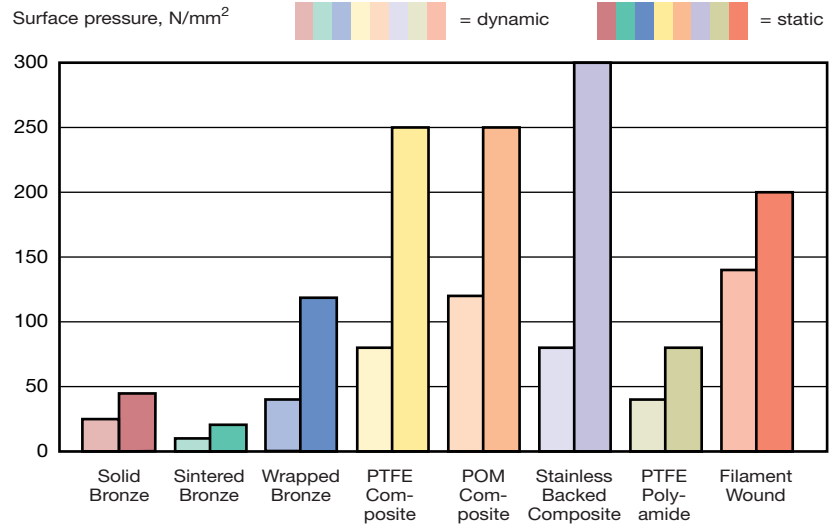

All sliding materials supplied by SKF can operate under rotational, oscillating and linear movements. The permissible sliding velocity for a specific application also depends on such factors as load, shaft surface and heat removed.

### Sliding velocity

Permissible continuous sliding velocity (m/s) at a load less than 1  $N/mm^2$  under dry or initially lubricated operating conditions for the different SKF sliding materials.

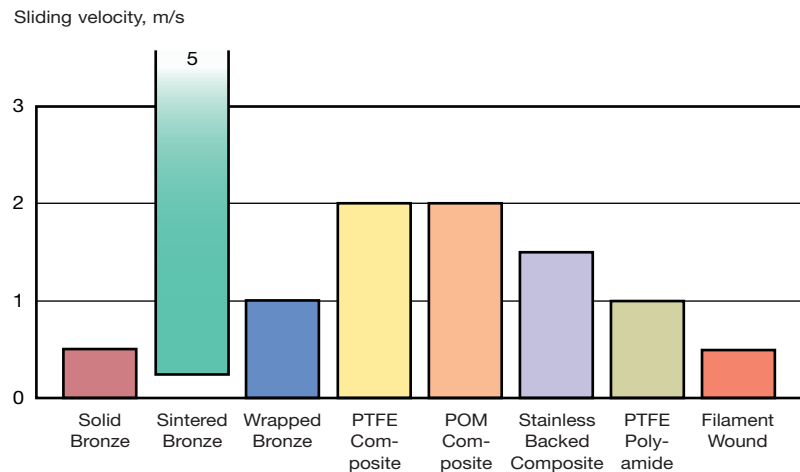

### Shaft recommendations

Recommended ISO tolerance, surface roughness and surface hardness of the shaft for the different SKF sliding materials.

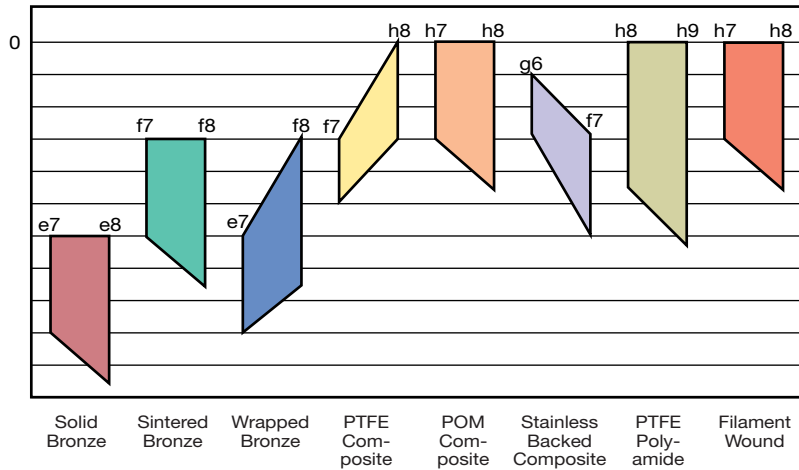

Shaft surface roughness  $R_a$ ,  $\mu\text{m}$

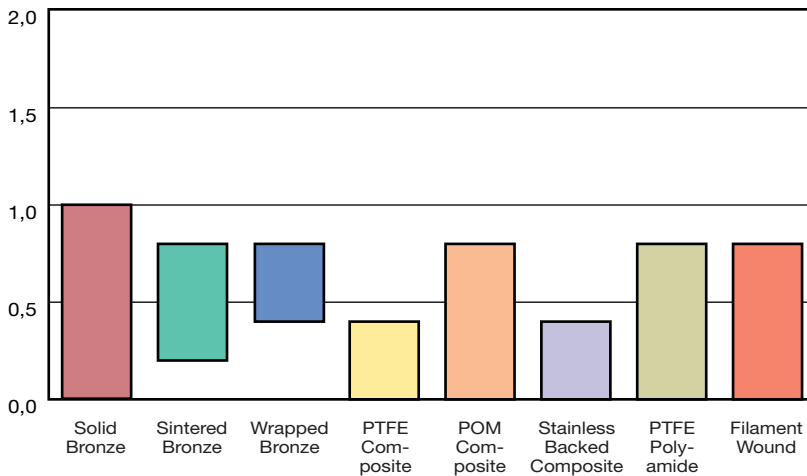

Shaft surface hardness, HB

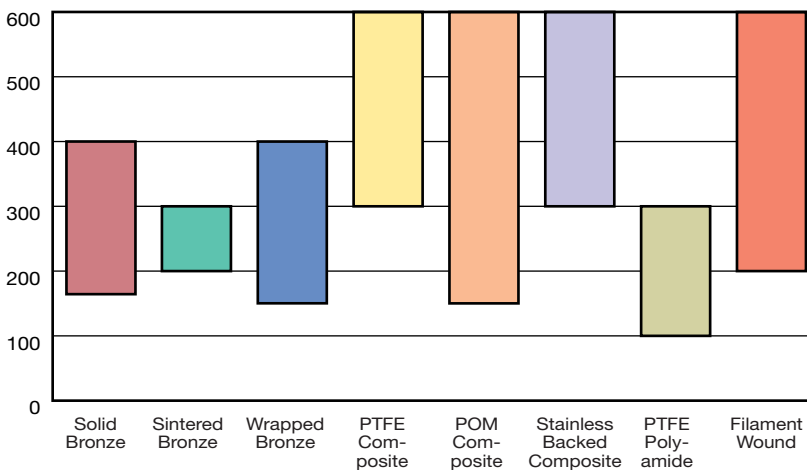

Higher tolerance grades can be used when the application demands are moderate.

The surface roughness often has a significant influence on the operating life. However, a surface roughness lower than  $0,04 \mu\text{m}$  may have a negative effect.

The heavier the load, the harder the shaft should be.

High risk for embedding inprinting will also require a harder shaft.



# SKF Solid Bronze

## The all-round runner

### THE TRADITIONAL AND ROBUST BUSHING MATERIAL

No other cylindrical bushing is used in as many and as varied applications as solid bronze bushings. The solid bronze material is ideally suited for highly demanding applications in tough environments. SKF offers a standard assortment of both plain and flanged cylindrical bushings in accordance with ISO 4379 and DIN1850.

SKF Solid Bronze bushings offer many features and advantages such as:

- insensitive to dirty environment
- resistant to shock loads and vibrations at slow speeds
- enable operation with a poor shaft surface finish
- good resistance to corrosive conditions
- lubrication groove

### MATERIAL

SKF Solid Bronze bushings are made of a multi-component bronze, CuSn7ZnPb, which has a very good sliding properties. All surfaces of the solid bronze bushings are machined.

### MAIN APPLICATIONS<sup>1)</sup>

SKF Solid Bronze bushings are intended for oscillating movements in both rotational and axial directions. SKF Solid Bronze bushings are not intended for rotating movements at medium or high speeds.

Examples of applications are:

- construction machinery
- transport equipment
- pulp and papermaking machinery
- off-shore equipment

### LUBRICATION

SKF Solid Bronze bushings are intended to be lubricated with oil or grease. Lubrication not only improves the sliding properties, but also reduces wear and prevents corrosion. Grease is usually used when lubrication is periodical, while in exceptional cases, an oil bath is used. Seals are recommended when the bushing is to be used in an aggressive environment.

All bushings with bore diameter of 14 mm and above incorporate an axial lubrication groove.

### Positioning of lubrication groove at different running conditions

rotating movement

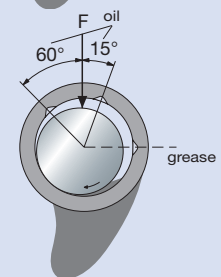
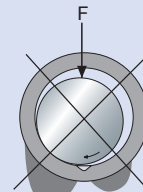

pendulum movement

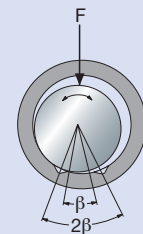

### Characteristics:

Permiss. load (dyn/stat), N/mm <sup>2</sup>	25/45
Permiss. sliding velocity, m/s	0,5
Friction coefficient $\mu$ (greased)	0,08 .. 0,15
Temperature range, °C	-40 .. +250

### Application recommendations:

Shaft tolerance	e7 – e8
Housing tolerance	H7
Shaft roughness $R_a$ , $\mu\text{m}$	< 1,0
Shaft hardness, HB	> 165

<sup>1)</sup> The performance of SKF Solid Bronze bushings depends on the interaction of load, lubrication, surface roughness, sliding velocity, and temperature encountered in specific applications.

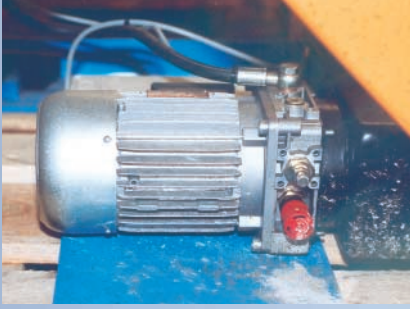

# SKF Sintered Bronze

## The fast runner

### OIL IMPREGNATION ALLOWS VERY HIGH SLIDING VELOCITY

SKF Sintered Bronze cylindrical bushings are all self-lubricating and maintenance-free. The sintered bronze bushings consist of a porous bronze matrix impregnated with lubricant. The permissible sliding velocity for sintered bronze bushings is very high, which makes the bushings suitable for rotating applications. SKF offers a full range of both plain and flanged cylindrical bushings.

SKF Sintered Bronze bushings offer many features and advantages such as:

- very high sliding velocity
- no external lubrication required
- maintenance-free operation
- good frictional properties

### MATERIAL

SKF Sintered Bronze consists of a sintered metallic bronze and graphite matrix (1 % weight of graphite) with fully impregnated porosity. The material composition in SKF Sintered Bronze bushings is SINT A51 with a porosity volume of 28 % impregnated with mineral oil. Machining or grinding of the sliding surface of a porous sintered bushing is not recommended due to the risk of closing the bearing pores.

### MAIN APPLICATIONS<sup>1)</sup>

SKF Sintered Bronze bushings are most suitable for applications with rotating movements and where the self-lubricating performance requirements are high.

Examples of applications are:

- electrical equipment
- household equipment
- printing machinery
- machine tools

### LUBRICATION

While storing and mounting make sure that the bushing never comes into contact with any absorbent material, as this may drain the oil very quickly. It is therefore recommended to keep the bushing in the original packaging for as long as possible.

Additional lubrication is usually not necessary.

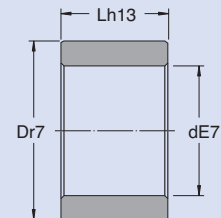
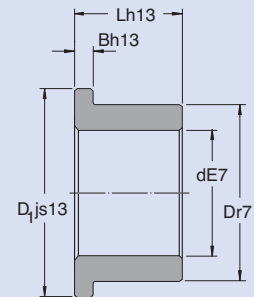

#### Characteristics:

Permiss. load (dyn/stat), N/mm <sup>2</sup>	10/20
Permiss. sliding velocity, m/s	5
Friction coefficient $\mu$	0,05 .. 0,10
Temperature range, °C	-10 .. +90

#### Application recommendations:

Shaft tolerance	f7 – f8
Housing tolerance	H7
Shaft roughness $R_a$ , $\mu\text{m}$	0,2 .. 0,8
Shaft hardness, HB	200 – 300

<sup>1)</sup> The performance of SKF Sintered Bronze bushings depends on the interaction of load, lubrication, surface roughness, sliding velocity, and temperature encountered in specific applications.



# SKF Wrapped Bronze

## The cross country runner

### EXCELLENT IN DIRTY ENVIRONMENTS DUE TO LUBRICATION POCKETS

SKF Wrapped Bronze cylindrical bushings are made completely of bronze. They are particularly suitable for applications which must be re-lubricated due to dirty environments. The sliding surface is provided with lubrication pockets which contribute to the enhanced lubrication performance. SKF offers a full range of both plain and flanged cylindrical bushings in accordance with ISO 3547 and DIN 1494.

SKF Wrapped Bronze bushings offer many features and advantages such as:

- insensitive to dirty environments
- resistant to shock loads and vibrations at slow speeds
- good resistance to corrosive conditions

### MATERIAL

SKF Wrapped Bronze is made completely of bronze, CuSn8. The bushings are produced from strips which are then wrapped and calibrated. The working surface is machined and provided with diamond shaped indentations all over its sliding surface. These indentations serve as lubricant reservoirs, where lubricant is initially filled and progressively released during operation.

### MAIN APPLICATIONS<sup>1)</sup>

SKF Wrapped Bronze bushings are suitable for both radial and axial movements. The bushings are well suited for machinery in dirty environments where shock loads and/or vibrations occur.

Examples of applications are:

- agricultural machinery
- hoisting equipment
- construction machinery
- forest machinery

### LUBRICATION

Lubrication improves the sliding properties, reduces wear and prevents corrosion since the metal surfaces of bushing and shaft are separated from each other. SKF Wrapped Bronze bushings are intended to be lubricated with grease or oil. All commonly used greases can be used. Seals are recommended when the bearing is to be used in an aggressive environment.

Diamond-shaped lubricant reservoirs



#### Characteristics:

Permiss. load (dyn/stat), N/mm <sup>2</sup>	40/120
Permiss. sliding velocity, m/s	1,0
Friction coefficient $\mu$ (greased)	0,08 .. 0,15
Temperature range, °C	-40 .. +150

#### Application recommendations:

Shaft tolerance	e7 – f8
Housing tolerance	H7
Shaft roughness $R_a$ , $\mu\text{m}$	0,4 .. 0,8
Shaft hardness, HB	150 – 400

<sup>1)</sup> The performance of SKF Wrapped Bronze bushings depends on the interaction of load, lubrication, surface roughness, sliding velocity, and temperature encountered in specific applications.





# SKF PTFE Composite

## The long runner

### LONG MAINTENANCE-FREE OPERATING LIFE DUE TO LOW FRICTION

In applications where other materials have shown insufficient operating life SKF PTFE Composite dry sliding bearings can be the solution. SKF PTFE Composite is specially designed to operate without lubricant and is particularly suited for high load/medium speed applications. SKF offers a full range of cylindrical bushings in accordance with ISO 3547 and DIN 1494 as well as flanged bushings, thrust washers and strip.

SKF PTFE Composite bearings offer many features and advantages such as:

- maintenance-free operation
- very good frictional properties
- high load capacity
- operating temperatures up to 250 °C
- sliding velocity up to 2 m/s
- small operating clearance

### MATERIAL

SKF PTFE Composite dry sliding bearings combine the mechanical strength of steel with the low friction of a PTFE-based self-lubricating sliding layer. The intermediate layer of porous tin bronze guarantees a strong bond between the backing and sliding surface and also improves the dissipation of heat generated during operation. The bearing is available in two versions. One with a sliding layer without any lead. This version has the suffix E. Another version where the sliding layer contains a minor amount of lead incorporates the suffix B. To protect the bearings from corrosion the steel backing is tin-plated. All SKF PTFE Composite dry sliding bearings can be machined, except for the sliding surface. However, a calibration is possible within certain limits.

<sup>1)</sup> The performance of SKF PTFE Composite bearings depends on the interaction of load, lubrication, surface roughness, sliding velocity, and temperature encountered in specific applications.  
*Note:* Because of the lead content, SKF PTFE Composite type B should not be used in contact with food, beverage or pharmaceutical products. Try to use SKF PTFE composite type E, SKF POM or Stainless Backed Composite bushings instead.

### MAIN APPLICATIONS<sup>1)</sup>

SKF PTFE Composite dry sliding bearings are suitable for applications where the load and self-lubrication requirements are high.

Examples of applications are:

- automotive applications
- materials handling equipment
- home appliances and consumer goods
- textile machinery

### LUBRICATION

The PTFE-based sliding surface permits smooth, low-friction operation without lubrication or maintenance. During the running-in phase part of the covering layer of SKF PTFE Composite dry sliding bearings is transferred to the mating surface and forms a physically bonded lubricant film.

The presence or continuous supply of oil or other non corrosive fluids may be advantageous and improve the performance of these bearings.

Cross section of SKF PTFE Composite

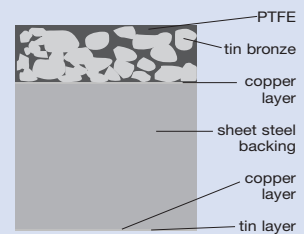

<b>Characteristics:</b>	
Permiss. load (dyn/stat), N/mm <sup>2</sup>	80/250
Permiss. sliding velocity, m/s	2,0 (p ≤ 1,0)
Friction coefficient μ	0,03 .. 0,25
Temperature range, °C	-200 .. +250
<b>Application recommendations:</b>	
Shaft tolerance	f7 – h8
Housing tolerance	H7
Shaft roughness R <sub>a</sub> , μm	0 .. 0,4
Shaft hardness, HB	300 – 600

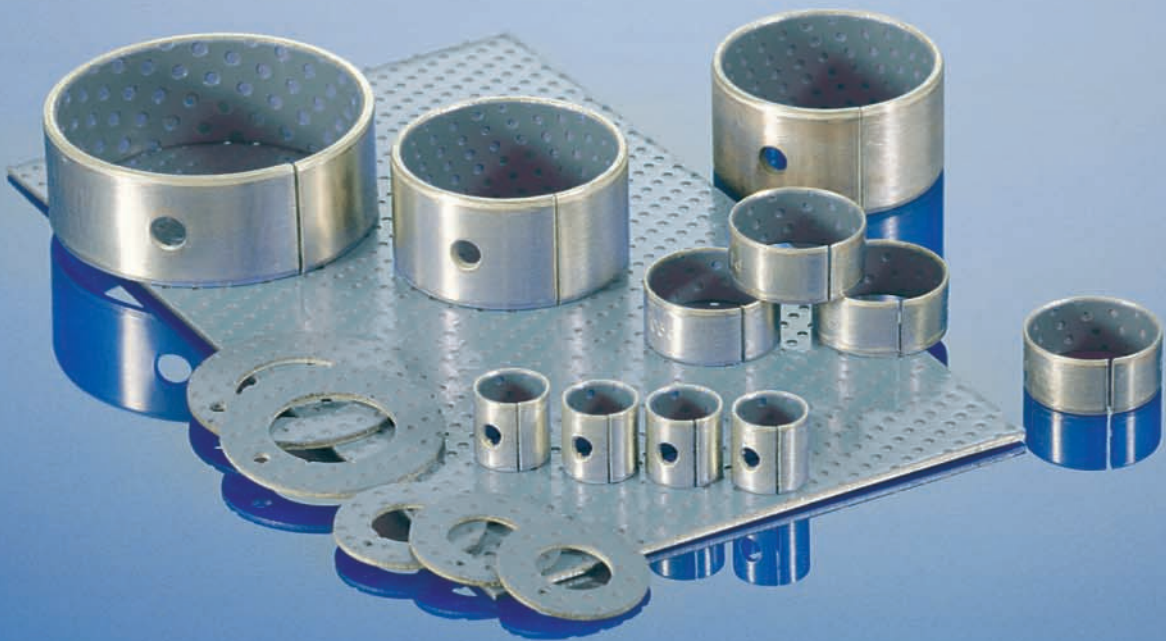

# SKF POM Composite

## The up-hill runner

### OPTIMAL COMBINATION OF LOW MAINTENANCE UNDER TOUGH RUNNING CONDITIONS

SKF POM Composite is referred to as pre-lubricated because it requires only a trace of lubricant to operate satisfactorily for long periods. The material is designed to operate with marginal lubrication and effectively fills the gap between fully lubricated bearings and dry sliding bearings. SKF offers a full range of plain cylindrical bushings in accordance with ISO 3547 and DIN 1494, as well as thrust washers and strip.

SKF POM Composite bushings offer many features and advantages such as:

- maintenance-free operation
- very good frictional properties
- high load capacity
- high sliding velocity
- small operating clearance

### MATERIAL

SKF POM Composite sliding bearings are specially designed to operate with marginal lubrication. The sliding surface has a highly effective grease retention system with lubrication pockets, which serve as grease reservoirs. SKF POM Composite consists of three bonded layers: a copper plated steel backing strip and a sintered porous tin bronze matrix covered with an acetal (polyoxymethylene, POM) resin. To protect the bearing from corrosion the steel backing is tin plated. All SKF POM Composite sliding bearings can be machined. However, any machining of the sliding surface should only be undertaken in exceptional cases.

### MAIN APPLICATIONS<sup>1)</sup>

SKF POM Composite sliding bearings are suited for low-maintenance applications in tough running conditions. As a result of the lubricant retention pockets on the sliding surface, SKF POM Composite bearings are especially well suited for applications in dirty environments where lubricant cannot be supplied continuously or frequently.

Examples of applications are:

- agricultural equipment
- construction machinery
- materials handling equipment
- home appliances and consumer goods

### LUBRICATION

SKF POM Composite bearings are designed to operate with marginal lubrication and should initially be lubricated with grease. It is not necessary to re-lubricate, but the presence or continuous supply of lubricant extends bearing life considerably. To protect the mating surface against corrosion, grease can be periodically applied.

Cross section of SKF POM Composite

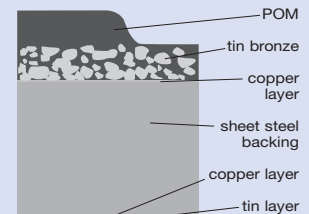

#### Characteristics:

Permiss. load (dyn/stat), N/mm <sup>2</sup>	120/250
Permiss. sliding velocity, m/s	2,0 (p ≤ 1,0)
Friction coefficient μ	0,04 .. 0,12
Temperature range, °C	-40 .. +110

#### Application recommendations:

Shaft tolerance	h7 – h8
Housing tolerance	H7
Shaft roughness R <sub>a</sub> , μm	0 .. 0,8
Shaft hardness, HB	150 – 600

<sup>1)</sup> The performance of SKF POM Composite bearings depends on the interaction of load, lubrication, surface roughness, sliding velocity, and temperature encountered in specific applications.

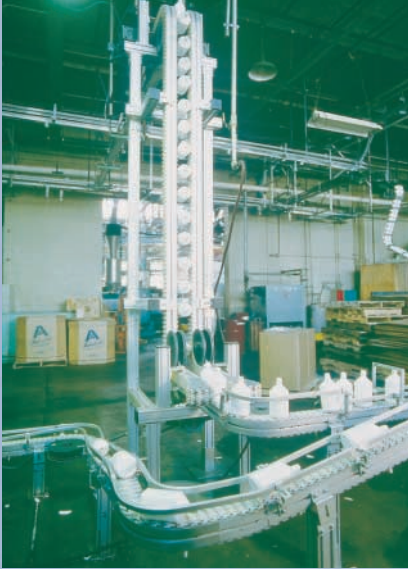
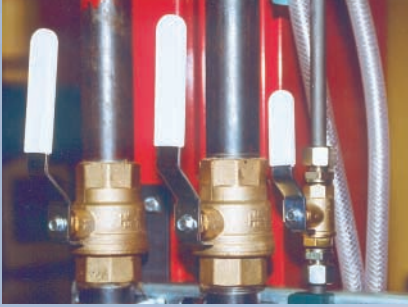

# SKF Stainless Backed Composite

## The smooth & shiny runner

### THE NON-CORROSIVE MAINTENANCE-FREE LONG-RUNNER

SKF Stainless Backed Composite dry sliding cylindrical bushings\* are specially developed for maintenance-free applications requiring high resistance to corrosive environments. SKF Stainless Backed Composite bushings are designed to operate without lubricant and are particularly suited for highly loaded applications. SKF offers a standard assortment of plain cylindrical bushings according to ISO 3547 and DIN 1494.

SKF Stainless Backed Composite bushings offer many features and advantages such as:

- excellent resistance to corrosive conditions
- very good frictional properties
- maintenance-free operation
- high load capacity
- high sliding velocity
- small operating clearance

### MATERIAL

SKF Stainless Backed Composite is made out of a stainless steel backing strip (AISI 316TI) covered with PTFE fibres consisting of multi-filament yarns. The PTFE yarn is woven together with metal wire to produce a double-sided fabric, with only PTFE fibres on the sliding surface. The metal side of the fabric is continuously soldered to the stainless steel backing. The PTFE side of the fabric is coated with a thermosetting resin preventing creep of the fabric under heavy loads. All SKF Stainless Backed Composite dry sliding bushings can be machined. However, any machining of the sliding surface should be avoided.

<sup>1)</sup> The performance of SKF Stainless Backed Composite bushings depends on the interaction of load, lubrication, surface roughness, sliding velocity, and temperature encountered in specific applications.

### MAIN APPLICATIONS<sup>1)</sup>

SKF Stainless Backed Composite bushings are able to sustain heavy load under low sliding velocity conditions in a corrosive environment.

Examples of applications are:

- food and packaging industry
- valves and pumps
- medical equipment
- printing and papermaking machines
- off-shore industry

### LUBRICATION

SKF Stainless Backed Composite bushings are completely self-lubricating. The PTFE fibre and the thermosetting resin permit low friction operation with no lubrication or maintenance. During a brief running-in phase part of the PTFE covering layer is transferred to the mating surface.

Cross section of SKF Stainless Backed Composite

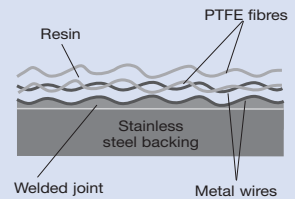

#### Characteristics:

Permiss. load (dyn/stat), N/mm <sup>2</sup>	80/300
Permiss. sliding velocity, m/s	1,5
Friction coefficient $\mu$	0,03 .. 0,08
Temperature range, °C	-150 .. +150

#### Application recommendations:

Shaft tolerance	g6 – f7
Housing tolerance	H7
Shaft roughness $R_a$ , $\mu\text{m}$	0 .. 0,4
Shaft hardness, HB	300 – 600

\* Branded Pydane in France. Pydane is a registered trademark of the SKF Group.

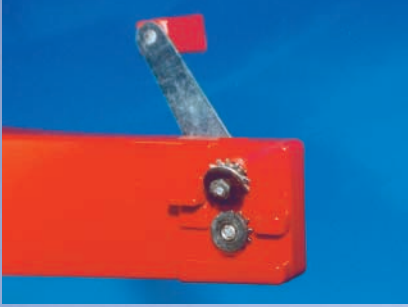

# SKF PTFE Polyamide

## The jogging runner

### THE COST EFFECTIVE MAINTENANCE-FREE BUSHING

The thermoplastic material of SKF PTFE Polyamide cylindrical bushings offers maintenance-free, dry sliding operation. SKF PTFE Polyamide bushings are designed for applications where other polymer bushings have shown insufficient operating life. The small wall thickness of these bushings ensures good heat conducting characteristics, enabling high sliding velocities. SKF offers a standard assortment of both plain and flanged cylindrical bushings according to ISO 3547 and DIN 1494.

SKF PTFE Polyamide bushings offer many features and advantages such as:

- maintenance-free operation
- cost efficiency
- excellent resistance to corrosive conditions
- electrically insulating properties

### MATERIAL

SKF PTFE Polyamide comprises a thermoplastic base material, with both PTFE additives and glass-fibre. The material mix of SKF PTFE Polyamide bushings results in self-lubricating low wear performance and, in many applications, adequate load capacity.

### MAIN APPLICATIONS<sup>1)</sup>

SKF PTFE Polyamide bushings are suitable for applications where cost effective maintenance-free bushings are preferred.

Examples of applications are:

- textile industry
- medical equipment
- fitness equipment
- household equipment

### LUBRICATION

SKF PTFE Polyamide is designed for dry operation. Lubrication can, however, improve the performance of these bushings. By continuously lubricating with grease, oil, water or other liquids, the operating speed can be increased still further. SKF PTFE Polyamide is resistant to most lubricant oils and greases.

<sup>1)</sup> The performance of SKF PTFE Polyamide bushings depends on the interaction of load, lubrication, surface roughness, sliding velocity, and temperature encountered in specific applications.

<b>Characteristics:</b>	
Permiss. load (dyn/stat), N/mm <sup>2</sup>	40/80
Permiss. sliding velocity, m/s	1,0
Friction coefficient $\mu$	0,06 .. 0,15
Temperature range °C	-30 .. +110
<b>Application recommendations:</b>	
Shaft tolerance	h8 – h9
Housing tolerance	H7
Shaft roughness R <sub>a</sub> , $\mu$ m	0 .. 0,8
Shaft hardness, HB	100 – 300





# SKF Filament Wound

## The heavy duty runner

### THE MAINTENANCE-FREE BUSHING FOR EXTREME RUNNING CONDITIONS

SKF Filament Wound dry sliding cylindrical bushings are made out of resin and fibres wound in multi-layers. This material has been developed specially for applications with high loads, vibration and/or a corrosive environment. SKF Filament Wound bushings are most often interchangeable with solid bronze and steel bushings. SKF offers a standard assortment of plain cylindrical bushings in accordance with ISO 4379 and DIN 1850.

SKF Filament Wound bushings offer many features and advantages such as:

- high load capacity
- excellent resistance to shock loads and vibrations
- low sensitivity to edge pressure and misalignment
- maintenance-free operation
- excellent resistance to corrosive conditions
- very good frictional properties
- electrically insulating properties

### MATERIAL

The modern technique of fibre winding, together with a specially developed resin matrix, combines the outstanding mechanical properties of glass-fibre with the excellent tribological behaviour of PTFE and high strength thermoplastic PES fibres. All SKF Filament Wound bushings can be mechanically machined, except for the sliding layer. In all cases care must be taken to avoid an excessive temperature rise as this could damage the bearing.

### MAIN APPLICATIONS<sup>1)</sup>

SKF Filament Wound bushings are suitable in applications where high loads and vibrations occur and where maintenance-free operation is preferred.

Examples of applications are:

- construction machinery
- agricultural and forestry machinery
- hoisting and conveyor equipment
- offshore equipment
- metal working machines

### LUBRICATION

SKF Filament Wound bushings are dry running thanks to the unique sliding surface with PTFE and PES fibres in an epoxy resin. The sliding surface permits low friction operation with no lubrication or maintenance. However, the presence of lubricant offers protection against contamination and has no negative effect. Seals are recommended when the bushing is to be used in an aggressive environment.

Cross section of SKF Filament Wound

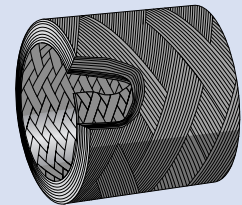

<b>Characteristics:</b>	
Permiss. load (dyn/stat), N/mm <sup>2</sup>	140/200
Permiss. sliding velocity, m/s	0,5
Friction coefficient $\mu$	0,03 .. 0,08
Temperature range, °C	-50 .. +140
<b>Application recommendations:</b>	
Shaft tolerance	h7 – h8
Housing tolerance	H7
Shaft roughness R <sub>a</sub> , $\mu\text{m}$	0 .. 0,8
Shaft hardness, HB	200 – 600

<sup>1)</sup> The performance of SKF Filament Wound bushings depends on the interaction of load, lubrication, surface roughness, sliding velocity, and temperature encountered in specific applications.



# Stock Assortment



<b>SKF Solid Bronze</b>	<b>28</b>
<b>SKF Sintered Bronze</b>	<b>32</b>
<b>SKF Wrapped Bronze</b>	<b>36</b>
<b>SKF PTFE Composite</b>	<b>38</b>
<b>SKF POM Composite</b>	<b>44</b>
<b>SKF Stainless Backed Composite</b>	<b>48</b>
<b>SKF PTFE Polyamide</b>	<b>50</b>
<b>SKF Filament Wound</b>	<b>52</b>

# SKF Solid Bronze – plain cylindrical bushings

## Construction of designation:

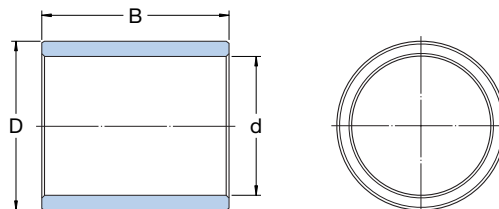
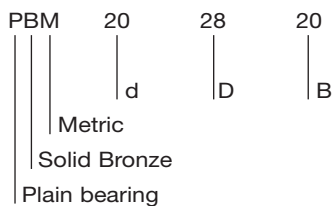

Designation	d mm	D mm	B mm	Designation	d mm	D mm	B mm
PBM 051006 M1	5	10	6	PBM 223220 M1G1	22	32	20
PBM 051008 M1	5	10	8	PBM 223230 M1G1	22	32	30
PBM 051010 M1	5	10	10	PBM 223240 M1G1	22	32	40
PBM 061206 M1	6	12	6	PBM 253525 M1G1	25	35	25
PBM 061208 M1	6	12	8	PBM 253535 M1G1	25	35	35
PBM 061212 M1	6	12	12	PBM 253550 M1G1	25	35	50
PBM 071208 M1	7	12	8	PBM 284025 M1G1	28	40	25
PBM 071210 M1	7	12	10	PBM 284035 M1G1	28	40	35
PBM 071212 M1	7	12	12	PBM 284050 M1G1	28	40	50
PBM 081408 M1	8	14	8	PBM 304030 M1G1	30	40	30
PBM 081412 M1	8	14	12	PBM 304045 M1G1	30	40	45
PBM 081416 M1	8	14	16	PBM 304060 M1G1	30	40	60
PBM 091410 M1	9	14	10	PBM 354535 M1G1	35	45	35
PBM 091416 M1	9	14	16	PBM 354550 M1G1	35	45	50
PBM 091420 M1	9	14	20	PBM 354570 M1G1	35	45	70
PBM 101610 M1	10	16	10	PBM 405040 M1G1	40	50	40
PBM 101616 M1	10	16	16	PBM 405060 M1G1	40	50	60
PBM 101620 M1	10	16	20	PBM 405080 M1G1	40	50	80
PBM 121812 M1	12	18	12	PBM 455545 M1G1	45	55	45
PBM 121816 M1	12	18	16	PBM 455560 M1G1	45	55	60
PBM 121825 M1	12	18	25	PBM 455580 M1G1	45	55	80
PBM 142012 M1G1	14	20	12	PBM 506050 M1G1	50	60	50
PBM 142020 M1G1	14	20	20	PBM 506070 M1G1	50	60	70
PBM 142030 M1G1	14	20	30	PBM 5060100 M1G1	50	60	100
PBM 152216 M1G1	15	22	16	PBM 557050 M1G1	55	70	50
PBM 152220 M1G1	15	22	20	PBM 557070 M1G1	55	70	70
PBM 152230 M1G1	15	22	30	PBM 5570100 M1G1	55	70	100
PBM 162216 M1G1	16	22	16	PBM 607560 M1G1	60	75	60
PBM 162220 M1G1	16	22	20	PBM 607590 M1G1	60	75	90
PBM 162230 M1G1	16	22	30	PBM 6075120 M1G1	60	75	120
PBM 172516 M1G1	17	25	16	PBM 658060 M1G1	65	80	60
PBM 172520 M1G1	17	25	20	PBM 658090 M1G1	65	80	90
PBM 172530 M1G1	17	25	30	PBM 6580120 M1G1	65	80	120
PBM 182516 M1G1	18	25	16	PBM 708560 M1G1	70	85	60
PBM 182520 M1G1	18	25	20	PBM 708590 M1G1	70	85	90
PBM 182530 M1G1	18	25	30	PBM 7085120 M1G1	70	85	120
PBM 202820 M1G1	20	28	20	PBM 759070 M1G1	75	90	70
PBM 202830 M1G1	20	28	30	PBM 7590100 M1G1	75	90	100
PBM 202840 M1G1	20	28	40	PBM 7590140 M1G1	75	90	140

Other dimensions available on request

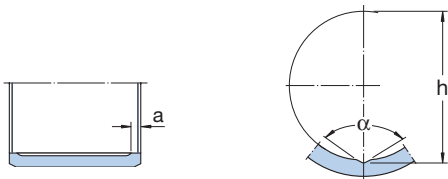

d mm	a mm	h mm	α °
14-22	3	d+1	105
25-55	3	d+1	124
60-130	B×0,05	d+1,5	124
140-190	B×0,05	d+2,0	124
>190	B×0,05	d+2,5	124

Designation	d mm	D mm	B mm
PBM 809570 M1G1	80	95	70
PBM 8095100 M1G1	80	95	100
PBM 8095140 M1G1	80	95	140
PBM 8510070 M1G1	85	100	70
PBM 85100100 M1G1	85	100	100
PBM 85100140 M1G1	85	100	140
PBM 9011080 M1G1	90	110	80
PBM 90110120 M1G1	90	110	120
PBM 90110160 M1G1	90	110	160
PBM 9511580 M1G1	95	115	80
PBM 95115120 M1G1	95	115	120
PBM 95115160 M1G1	95	115	160
PBM 10012080 M1G1	100	120	80
PBM 100120120 M1G1	100	120	120
PBM 100120160 M1G1	100	120	160
PBM 10512580 M1G1	105	125	80
PBM 105125120 M1G1	105	125	120
PBM 105125160 M1G1	105	125	160
PBM 11013080 M1G1	110	130	80
PBM 110130140 M1G1	110	130	140
PBM 110130200 M1G1	110	130	200
PBM 12014080 M1G1	120	140	80
PBM 120140140 M1G1	120	140	140
PBM 120140200 M1G1	120	140	200
PBM 13015090 M1G1	130	150	90
PBM 130150140 M1G1	130	150	200
PBM 130150200 M1G1	130	150	200
PBM 14016090 M1G1	140	160	90
PBM 140160160 M1G1	140	160	160
PBM 140160200 M1G1	140	160	200
PBM 150170100 M1G1	150	170	100
PBM 150170160 M1G1	150	170	160
PBM 150170240 M1G1	150	170	240
PBM 160180100 M1G1	160	180	100
PBM 160180160 M1G1	160	180	160
PBM 160180240 M1G1	160	180	240
PBM 170190100 M1G1	170	190	100
PBM 170190160 M1G1	170	190	160
PBM 170190240 M1G1	170	190	240

Designation	d mm	D mm	B mm
PBM 180200100 M1G1	180	200	100
PBM 180200160 M1G1	180	200	160
PBM 180200240 M1G1	180	200	240
PBM 190210120 M1G1	190	210	120
PBM 190210200 M1G1	190	210	300
PBM 190210300 M1G1	190	210	300
PBM 200220120 M1G1	200	220	120
PBM 200220200 M1G1	200	220	300
PBM 200220300 M1G1	200	220	300
PBM 210230120 M1G1	210	230	120
PBM 210230200 M1G1	210	230	200
PBM 210230300 M1G1	210	230	300
PBM 220240140 M1G1	220	240	140
PBM 220240250 M1G1	220	240	250
PBM 220240350 M1G1	220	240	350
PBM 230250140 M1G1	230	250	140
PBM 230250250 M1G1	230	250	250
PBM 230250350 M1G1	230	250	350
PBM 240260140 M1G1	240	260	140
PBM 240260250 M1G1	240	260	250
PBM 240260350 M1G1	240	260	350
PBM 250270140 M1G1	250	270	140
PBM 250270250 M1G1	250	270	250
PBM 250270350 M1G1	250	270	350

Other dimensions available on request

# SKF Solid Bronze – flanged cylindrical bushings

## Construction of designation:

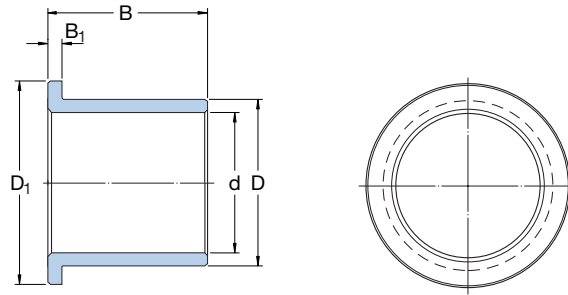
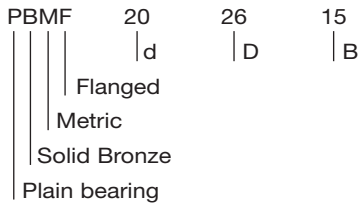

Designation	d mm	D mm	B mm	D <sub>1</sub> mm	B <sub>1</sub> mm	Designation	d mm	D mm	B mm	D <sub>1</sub> mm	B <sub>1</sub> mm
PBMF 051006 M1	5	10	6	12	2	PBMF 455530 M1G1	45	55	30	65	6
PBMF 061206 M1	6	12	6	14	2	PBMF 455545 M1G1	45	55	45	65	6
PBMF 071208 M1	7	12	8	16	3	PBMF 506030 M1G1	50	60	30	70	6
PBMF 081408 M1	8	14	8	18	3	PBMF 506050 M1G1	50	60	50	70	6
PBMF 091408 M1	9	14	8	18	3	PBMF 557030 M1G1	55	70	30	80	8
PBMF 091410 M1	9	14	10	18	3	PBMF 557050 M1G1	55	70	50	80	8
PBMF 101608 M1	10	16	8	20	3	PBMF 607535 M1G1	60	75	35	85	8
PBMF 101610 M1	10	16	10	20	3	PBMF 607560 M1G1	60	75	60	85	8
PBMF 121810 M1	12	18	10	22	3	PBMF 658035 M1G1	65	80	35	90	8
PBMF 121812 M1	12	18	12	22	3	PBMF 658060 M1G1	65	80	60	90	8
PBMF 142010 M1G1	14	20	10	25	3	PBMF 708535 M1G1	70	85	35	95	8
PBMF 142012 M1G1	14	20	12	25	3	PBMF 708560 M1G1	70	85	60	95	8
PBMF 152212 M1G1	15	22	12	28	3	PBMF 759040 M1G1	75	90	40	100	8
PBMF 152216 M1G1	15	22	16	28	3	PBMF 759070 M1G1	75	90	70	100	8
PBMF 162212 M1G1	16	22	12	28	4	PBMF 809540 M1G1	80	95	40	105	8
PBMF 162216 M1G1	16	22	16	28	4	PBMF 809570 M1G1	80	95	70	105	8
PBMF 172512 M1G1	17	25	12	32	4	PBMF 8510040 M1G1	85	100	40	110	8
PBMF 172516 M1G1	17	25	16	32	4	PBMF 8510070 M1G1	85	100	70	110	8
PBMF 182512 M1G1	18	25	12	32	4	PBMF 9011050 M1G1	90	110	50	120	8
PBMF 182516 M1G1	18	25	16	32	4	PBMF 9011080 M1G1	90	110	80	120	8
PBMF 202816 M1G1	20	28	16	35	4	PBMF 9511550 M1G1	95	115	50	125	8
PBMF 202820 M1G1	20	28	20	35	4	PBMF 9511580 M1G1	95	115	80	125	8
PBMF 223216 M1G1	22	32	16	40	5	PBMF 10012050 M1G1	100	120	50	130	8
PBMF 223220 M1G1	22	32	20	40	5	PBMF 10012080 M1G1	100	120	80	130	8
PBMF 253516 M1G1	25	35	16	45	5	PBMF 10512550 M1G1	105	125	50	135	8
PBMF 253525 M1G1	25	35	25	45	5	PBMF 10512580 M1G1	105	125	80	135	8
PBMF 284016 M1G1	28	40	16	50	5	PBMF 11013050 M1G1	110	130	50	140	8
PBMF 284025 M1G1	28	40	25	50	5	PBMF 11013080 M1G1	110	130	80	140	8
PBMF 304020 M1G1	30	40	20	50	5	PBMF 12014050 M1G1	120	140	80	150	8
PBMF 304030 M1G1	30	40	30	50	5	PBMF 12014080 M1G1	120	140	80	150	8
PBMF 354520 M1G1	35	45	20	55	5	PBMF 13015060 M1G1	130	150	60	165	10
PBMF 354535 M1G1	35	45	35	55	5	PBMF 13015090 M1G1	130	150	90	165	10
PBMF 405025 M1G1	40	50	25	60	6	PBMF 14016060 M1G1	140	160	60	175	10
PBMF 405040 M1G1	40	50	40	60	6	PBMF 14016090 M1G1	140	160	90	175	10

Other dimensions available on request

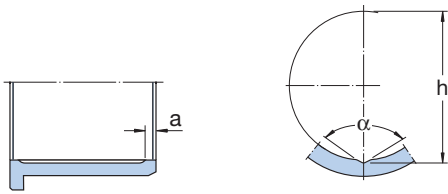

d mm	a mm	h mm	α °
14-22	3	d+1	105
25-55	3	d+1	124
60-130	B×0,05	d+1,5	124
140-190	B×0,05	d+2,0	124
>190	B×0,05	d+2,5	124

Designation	d mm	D mm	B mm	D <sub>1</sub> mm	B <sub>1</sub> mm
<b>PBMF 15017070 M1G1</b>	150	170	70	185	10
<b>PBMF 150170100 M1G1</b>	150	170	100	185	10
<b>PBMF 16018070 M1G1</b>	160	180	70	195	10
<b>PBMF 160180100 M1G1</b>	160	180	100	195	10
<b>PBMF 17019070 M1G1</b>	170	190	70	205	10
<b>PBMF 170190100 M1G1</b>	170	190	100	205	10
<b>PBMF 18020070 M1G1</b>	180	200	70	215	10
<b>PBMF 180200100 M1G1</b>	180	200	100	215	10
<b>PBMF 19021080 M1G1</b>	190	210	80	225	10
<b>PBMF 190210120 M1G1</b>	190	210	120	225	10
<b>PBMF 20022080 M1G1</b>	200	220	80	235	10
<b>PBMF 200220120 M1G1</b>	200	220	120	235	10
<b>PBMF 21023080 M1G1</b>	210	230	80	245	10
<b>PBMF 210230120 M1G1</b>	210	230	120	245	10
<b>PBMF 220240100 M1G1</b>	220	240	100	255	10
<b>PBMF 220240140 M1G1</b>	220	240	140	255	10
<b>PBMF 230250100 M1G1</b>	230	250	100	265	10
<b>PBMF 230250140 M1G1</b>	230	250	140	265	10
<b>PBMF 240260100 M1G1</b>	240	260	100	275	10
<b>PBMF 240260140 M1G1</b>	240	260	140	275	10
<b>PBMF 250270100 M1G1</b>	250	270	100	285	10
<b>PBMF 250270140 M1G1</b>	250	270	140	285	10

Other dimensions available on request



# SKF Sintered Bronze – plain cylindrical bushings

## Construction of designation:

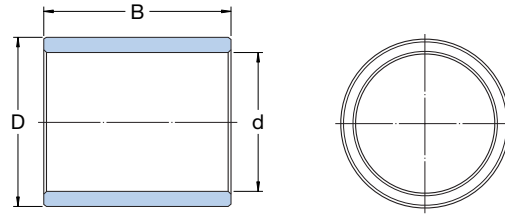
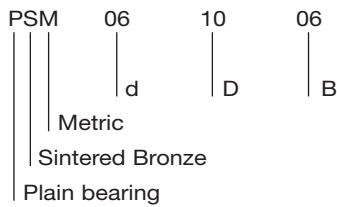

Designation	d mm	D mm	B mm
PSM 020404 A51	2	4	4
PSM 030804 A51	3	8	4
PSM 040708 A51	4	7	8
PSM 040804 A51	4	4	4
PSM 040806 A51	4	8	6
PSM 041008 A51	4	10	8
PSM 051006 A51	5	10	6
PSM 051008 A51	5	10	8
PSM 051010 A51	5	10	10
PSM 051210 A51	5	12	10
PSM 060904 A51	6	9	4
PSM 060906 A51	6	9	6
PSM 060910 A51	6	9	10
PSM 061004 A51	6	10	4
PSM 061006 A51	6	10	6
PSM 061010 A51	6	10	10
PSM 061206 A51	6	12	6
PSM 061208 A51	6	12	8
PSM 061212 A51	6	12	12
PSM 061412 A51	6	14	12
PSM 081106 A51	8	11	6
PSM 081108 A51	8	11	8
PSM 081112 A51	8	11	12
PSM 081206 A51	8	12	6
PSM 081208 A51	8	12	8
PSM 081212 A51	8	12	12
PSM 081408 A51	8	14	8
PSM 081412 A51	8	14	12
PSM 081416 A51	8	14	16
PSM 081816 A51	8	18	16
PSM 101408 A51	10	14	8
PSM 101410 A51	10	14	10
PSM 101416 A51	10	14	16
PSM 101608 A51	10	16	8
PSM 101610 A51	10	16	10
PSM 101616 A51	10	16	16
PSM 101620 A51	10	16	20
PSM 102220 A51	10	22	20
PSM 121608 A51	12	16	8
PSM 121612 A51	12	16	12
PSM 121620 A51	12	16	20
PSM 121808 A51	12	18	8
PSM 121812 A51	12	18	12

Designation	d mm	D mm	B mm
PSM 121816 A51	12	18	16
PSM 121820 A51	12	18	20
PSM 121825 A51	12	18	25
PSM 122525 A51	12	25	25
PSM 141810 A51	14	18	10
PSM 141814 A51	14	18	14
PSM 141820 A51	14	18	20
PSM 142010 A51	14	20	10
PSM 142012 A51	14	20	12
PSM 142014 A51	14	20	14
PSM 142020 A51	14	20	20
PSM 142030 A51	14	20	30
PSM 142830 A51	14	28	30
PSM 151910 A51	15	19	10
PSM 151915 A51	15	19	15
PSM 151925 A51	15	19	25
PSM 152010 A51	15	20	10
PSM 152015 A51	15	20	15
PSM 152020 A51	15	20	20
PSM 152025 A51	15	20	25
PSM 152030 A51	15	20	30
PSM 152110 A51	15	21	10
PSM 152115 A51	15	21	15
PSM 152125 A51	15	21	25
PSM 152216 A51	15	22	16
PSM 152220 A51	15	22	20
PSM 152230 A51	15	22	30
PSM 153030 A51	15	30	30
PSM 162012 A51	16	20	12
PSM 162016 A51	16	20	16
PSM 162025 A51	16	20	25
PSM 162212 A51	16	22	12
PSM 162216 A51	16	22	16
PSM 162220 A51	16	22	20
PSM 162225 A51	16	22	25
PSM 163230 A51	16	32	30
PSM 121608 A51	12	16	8
PSM 121612 A51	12	16	12
PSM 121620 A51	12	16	20
PSM 121808 A51	12	18	8
PSM 121812 A51	12	18	12
PSM 121816 A51	12	18	16
PSM 121820 A51	12	18	20
PSM 121825 A51	12	18	25
PSM 122525 A51	12	25	25

Other dimensions available on request

<b>Designation</b>	<b>d mm</b>	<b>D mm</b>	<b>B mm</b>	<b>Designation</b>	<b>d mm</b>	<b>D mm</b>	<b>B mm</b>
PSM 141810 A51	14	18	10	PSM 202515 A51	20	25	15
PSM 141814 A51	14	18	14	PSM 202520 A51	20	25	20
PSM 141820 A51	14	18	20	PSM 202525 A51	20	25	25
PSM 142010 A51	14	20	10	PSM 202530 A51	20	25	30
PSM 142012 A51	14	20	12	PSM 202615 A51	20	26	15
PSM 142014 A51	14	20	14	PSM 202620 A51	20	26	20
PSM 142020 A51	14	20	20	PSM 202625 A51	20	26	25
PSM 142030 A51	14	20	30	PSM 202630 A51	20	26	30
PSM 142830 A51	14	28	30	PSM 202820 A51	20	28	20
				PSM 202830 A51	20	28	30
PSM 151910 A51	15	19	10	PSM 202840 A51	20	28	40
PSM 151915 A51	15	19	15	PSM 204040 A51	20	40	40
PSM 151925 A51	15	19	25				
PSM 152010 A51	15	20	10	PSM 222715 A51	22	27	15
PSM 152015 A51	15	20	15	PSM 222720 A51	22	27	20
PSM 152020 A51	15	20	20	PSM 222725 A51	22	27	25
PSM 152025 A51	15	20	25	PSM 222320 A51	22	23	20
PSM 152030 A51	15	20	30	PSM 223230 A51	22	32	30
PSM 152110 A51	15	21	10				
PSM 152115 A51	15	21	15	PSM 253020 A51	25	30	20
PSM 152125 A51	15	21	25	PSM 253025 A51	25	30	25
PSM 152216 A51	15	22	16	PSM 253030 A51	25	30	30
PSM 152220 A51	15	22	20	PSM 253220 A51	25	32	20
PSM 152230 A51	15	22	30	PSM 253225 A51	25	32	25
PSM 153030 A51	15	30	30	PSM 253230 A51	25	32	30
PSM 162012 A51	16	20	12	PSM 253232 A51	25	32	32
PSM 162016 A51	16	20	16	PSM 253235 A51	25	32	35
PSM 162025 A51	16	20	25	PSM 253525 A51	25	35	25
PSM 162212 A51	16	22	12	PSM 253535 A51	25	35	35
PSM 162216 A51	16	22	16	PSM 253550 A51	25	35	50
PSM 162220 A51	16	22	20	PSM 254535 A51	25	45	35
PSM 162225 A51	16	22	25				
PSM 163230 A51	16	32	30	PSM 303520 A51	30	35	20
				PSM 303525 A51	30	35	25
PSM 182212 A51	18	22	12	PSM 303530 A51	30	35	30
PSM 182218 A51	18	22	18	PSM 303820 A51	30	38	20
PSM 182230 A51	18	22	30	PSM 303825 A51	30	38	25
PSM 182412 A51	18	24	12	PSM 303830 A51	30	38	30
PSM 182418 A51	18	24	18	PSM 303840 A51	30	38	40
PSM 182430 A51	18	24	30	PSM 304030 A51	30	40	30
PSM 182516 A51	18	25	16	PSM 304045 A51	30	40	45
PSM 182520 A51	18	25	20	pSM 304060 A51	30	40	60
PSM 182530 A51	18	25	30	PSM 305060 A51	30	50	60
PSM 183530 A51	18	35	30				

Other dimensions available on request

# SKF Sintered Bronze – plain cylindrical bushings

## Construction of designation:

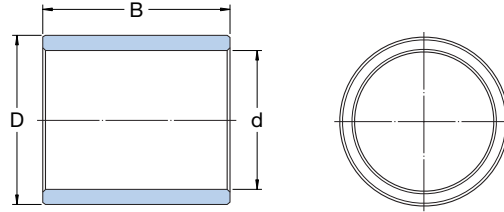
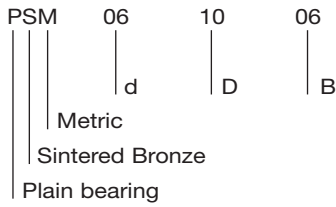

Designation	d mm	D mm	B mm
PSM 354125 A51	35	41	25
PSM 354135 A51	35	41	35
PSM 354140 A51	35	41	40
PSM 354525 A51	35	45	25
PSM 354535 A51	35	45	35
PSM 354540 A51	35	45	40
PSM 354550 A51	35	45	50
PSM 354570 A51	35	45	70
PSM 404630 A51	40	46	30
PSM 404640 A51	40	46	40
PSM 404650 A51	40	46	50
PSM 405030 A51	40	50	30
PSM 405040 A51	40	50	40
PSM 405050 A51	40	50	50
PSM 405060 A51	40	50	60
PSM 455135 A51	45	51	35
PSM 455145 A51	45	51	45
PSM 455155 A51	45	51	55
PSM 455535 A51	45	55	35
PSM 455545 A51	45	55	45
PSM 455555 A51	45	55	55
PSM 455560 A51	45	55	60
PSM 455565 A51	45	55	65
PSM 506035 A51	50	60	35
PSM 506050 A51	50	60	50
PSM 506070 A51	50	60	70
PSM 507070 A51	50	70	70
PSM 556540 A51	55	65	40
PSM 556555 A51	55	65	55
PSM 556570 A51	55	65	70
PSM 557070 A51	55	70	70
PSM 606850 A51	60	68	50
PSM 606860 A51	60	68	50
PSM 606870 A51	60	68	70
PSM 607050 A51	60	70	50
PSM 607060 A51	60	70	60
PSM 607250 A51	60	72	50
PSM 607260 A51	60	72	60
PSM 607270 A51	60	72	70
PSM 607560 A51	60	75	60
PSM 607590 A51	60	75	90
PSM 657560 A51	65	75	60
PSM 658060 A51	65	80	60

Designation	d mm	D mm	B mm
PSM 708060 A51	70	80	60
PSM 708560 A51	70	85	60
PSM 708590 A51	70	85	90
PSM 758570 A51	75	85	70
PSM 7585100 A51	75	85	100
PSM 759070 A51	75	90	70
PSM 7590100 A51	75	90	100
PSM 75100100 A51	75	100	100
PSM 809070 A51	80	90	70
PSM 809570 A51	80	95	70
PSM 8095100 A51	80	95	100
PSM 80105100 A51	80	105	100
PSM 8595100 A51	85	95	100
PSM 85100100 A51	85	100	100
PSM 9010580 A51	90	105	80
PSM 9011080 A51	90	110	80
PSM 10012080 A51	100	120	80

# SKF Sintered Bronze – flanged cylindrical bushings

## Construction of designation:

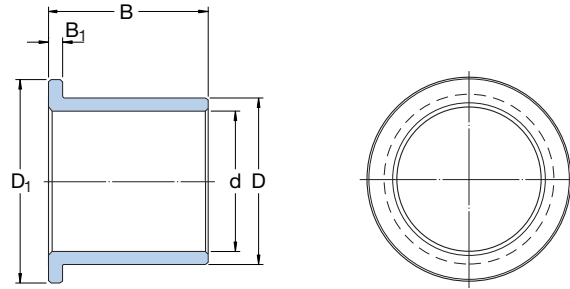
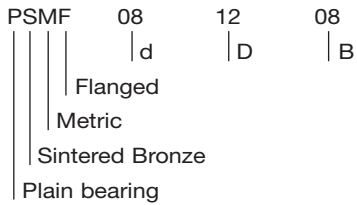

Designation	d mm	D mm	B mm	D <sub>1</sub> mm	B <sub>1</sub> mm	Designation	d mm	D mm	B mm	D <sub>1</sub> mm	B <sub>1</sub> mm
PSMF 030504 A51	3	5	4	8	1,5	PSMF 202615 A51	20	26	15	32	3
PSMF 030604 A51	3	6	4	9	1,5	PSMF 202620 A51	20	26	20	32	3
PSMF 040804 A51	4	8	4	12	2	PSMF 202625 A51	20	26	25	32	3
PSMF 040806 A51	4	8	6	12	2	PSMF 202630 A51	20	26	30	32	3
PSMF 050904 A51	5	9	4	13	2	PSMF 202816 A51	20	28	16	35	4
PSMF 050905 A51	5	9	5	13	2	PSMF 202820 A51	20	28	20	35	4
PSMF 050908 A51	5	9	8	13	2	PSMF 253220 A51	25	32	20	39	3,5
PSMF 051006 A51	5	10	6	12	2	PSMF 253225 A51	25	32	25	39	3,5
PSMF 061004 A51	6	10	4	14	2	PSMF 253230 A51	25	32	30	39	3,5
PSMF 061006 A51	6	10	6	14	2	PSMF 253516 A51	25	35	16	45	5
PSMF 061010 A51	6	10	10	14	2	PSMF 253525 A51	25	35	25	45	5
PSMF 061206 A51	6	12	6	14	2	PSMF 303830 A51	30	38	30	46	4
PSMF 081206 A51	8	12	6	16	2	PSMF 304020 A51	30	40	20	50	5
PSMF 081208 A51	8	12	8	16	2	PSMF 304030 A51	30	40	30	50	5
PSMF 081212 A51	8	12	12	16	2	PSMF 354520 A51	35	45	20	55	5
PSMF 081408 A51	8	14	8	18	3	PSMF 354525 A51	35	45	25	55	5
PSMF 101608 A51	10	16	8	22	3	PSMF 354535 A51	35	45	35	55	5
PSMF 101610 A51	10	16	10	22	3	PSMF 354540 A51	35	45	40	55	5
PSMF 101616 A51	10	16	16	22	3	PSMF 405030 A51	40	50	30	60	5
PSMF 121808 A51	12	18	08	24	3	PSMF 405040 A51	40	50	40	60	5
PSMF 121810 A51	12	18	10	24	3	PSMF 405050 A51	40	50	50	60	5
PSMF 121812 A51	12	18	12	24	3	PSMF 455530 A51	45	55	30	65	5
PSMF 121820 A51	12	18	20	24	3	PSMF 455535 A51	45	55	35	65	5
PSMF 142010 A51	14	20	10	26	3	PSMF 455545 A51	45	55	45	65	5
PSMF 142012 A51	14	20	12	26	3	PSMF 455555 A51	45	55	55	65	5
PSMF 142014 A51	14	20	14	26	3	PSMF 506030 A51	50	60	30	70	5
PSMF 142020 A51	14	20	20	26	3	PSMF 506035 A51	50	60	35	70	5
PSMF 152015 A51	15	20	15	27	3	PSMF 506050 A51	50	60	50	70	5
PSMF 152025 A51	15	20	25	27	3	PSMF 607250 A51	60	72	50	84	6
PSMF 152110 A51	15	21	10	27	3	PSMF 607260 A51	60	72	60	84	6
PSMF 152115 A51	15	21	15	27	3	PSMF 607535 A51	60	75	35	85	8
PSMF 152125 A51	15	21	25	27	3	PSMF 607560 A51	60	75	60	85	8
PSMF 152212 A51	15	22	12	28	3	PSMF 708560 A51	70	85	60	95	8
PSMF 152216 A51	15	22	16	28	3	PSMF 809570 A51	80	95	70	105	8
PSMF 162212 A51	16	22	12	28	3	PSMF 9011050 A51	90	110	50	120	8
PSMF 162216 A51	16	22	16	28	3	PSMF 10012080 A51	100	120	80	130	8
PSMF 162225 A51	16	22	25	28	3						
PSMF 182412 A51	18	24	12	30	3						
PSMF 182418 A51	18	24	18	30	3						
PSMF 182430 A51	18	24	30	30	3						
PSMF 182512 A51	18	25	12	32	4						
PSMF 182516 A51	18	25	16	32	4						

Other dimensions available on request

# SKF Wrapped Bronze – plain cylindrical bushings

## Construction of designation:

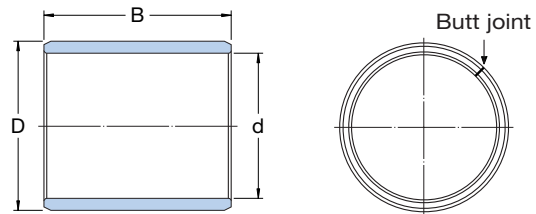
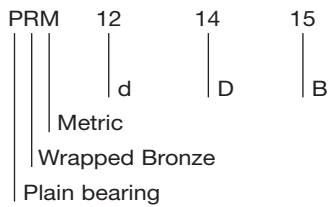

Designation	d mm	D mm	B mm	Designation	d mm	D mm	B mm
PRM 121415	12	14	15	PRM 455030	45	50	30
PRM 151715	15	17	15	PRM 455040	45	50	40
PRM 151725	15	17	25	PRM 455050	45	50	50
PRM 161815	16	18	15	PRM 455060	45	50	60
PRM 161820	16	18	20	PRM 505530	50	55	30
PRM 161825	16	18	25	PRM 505540	50	55	40
PRM 182115	18	21	15	PRM 505550	50	55	50
PRM 182120	18	21	20	PRM 505560	50	55	60
PRM 182125	18	21	25	PRM 556040	55	60	40
PRM 202315	20	23	15	PRM 556060	55	60	60
PRM 202320	20	23	20	PRM 606530	60	65	30
PRM 202325	20	23	25	PRM 606540	60	65	40
PRM 202330	20	23	30	PRM 606550	60	65	50
PRM 252815	25	28	15	PRM 606560	60	65	60
PRM 252820	25	28	20	PRM 657040	65	70	40
PRM 252825	25	28	25	PRM 657060	65	70	60
PRM 252830	25	28	30	PRM 707540	70	75	40
PRM 303420	30	34	20	PRM 707560	70	75	60
PRM 303430	30	34	30	PRM 707580	70	75	80
PRM 303440	30	34	40	PRM 758080	75	80	80
PRM 323620	32	36	20	PRM 808540	80	85	40
PRM 323630	32	36	30	PRM 808560	80	85	60
PRM 353920	35	39	20	PRM 808580	80	85	80
PRM 353930	35	39	30	PRM 859080	85	90	80
PRM 353940	35	39	40	PRM 909550	90	95	50
PRM 353950	35	39	50	PRM 909590	90	95	90
PRM 404420	40	44	20	PRM 10010550	100	105	50
PRM 404430	40	44	30	PRM 10010595	100	105	95
PRM 404440	40	44	40				
PRM 404450	40	44	50				

Other dimensions available on request

# SKF Wrapped Bronze – flanged cylindrical bushings

## Construction of designation:

PRMF	20	23	16
	d	D	B
	Flanged		
	Metric		
	Wrapped Bronze		
	Plain bearing		

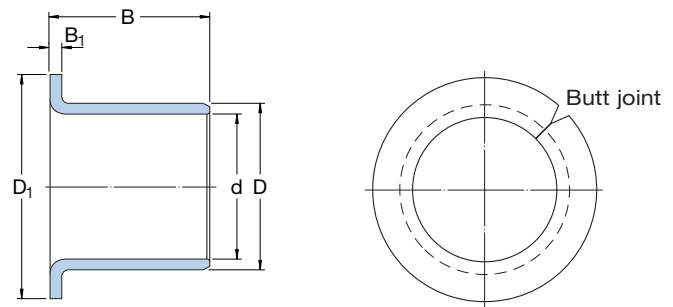

Designation	d mm	D mm	B mm	D <sub>1</sub> mm	B <sub>1</sub> mm
<b>PRMF 202316</b>	20	23	16	30	1,5
<b>PRMF 202320</b>	20	23	20	30	1,5
<b>PRMF 252815</b>	25	28	15	35	1,5
<b>PRMF 252825</b>	25	28	25	35	1,5
<b>PRMF 303420</b>	30	34	20	45	2
<b>PRMF 303430</b>	30	34	30	45	2
<b>PRMF 353920</b>	35	39	20	50	2
<b>PRMF 353935</b>	35	39	35	50	2
<b>PRMF 404425</b>	40	44	25	55	2
<b>PRMF 404440</b>	40	44	40	55	2
<b>PRMF 455030</b>	45	50	30	60	2,5
<b>PRMF 455045</b>	45	50	45	60	2,5
<b>PRMF 505530</b>	50	55	30	65	2,5
<b>PRMF 505550</b>	50	55	50	65	2,5

Designation	d mm	D mm	B mm	D <sub>1</sub> mm	B <sub>1</sub> mm
<b>PRMF 556050</b>	55	60	50	70	2,5
<b>PRMF 606530</b>	60	65	30	75	2,5
<b>PRMF 606560</b>	60	65	60	75	2,5
<b>PRMF 657060</b>	65	70	60	80	2,5
<b>PRMF 707540</b>	70	75	40	85	2,5
<b>PRMF 707570</b>	70	75	70	85	2,5
<b>PRMF 758070</b>	75	80	70	90	2,5
<b>PRMF 808540</b>	80	85	40	100	2,5
<b>PRMF 808580</b>	80	85	80	100	2,5
<b>PRMF 909550</b>	90	95	50	110	2,5
<b>PRMF 10010550</b>	100	105	50	120	2,5

# SKF PTFE Composite – plain cylindrical bushings

## Construction of designation:

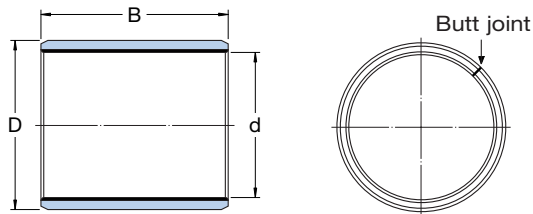
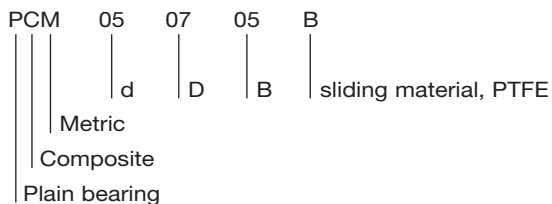

Designation	d mm	D mm	B mm	Designation	d mm	D mm	B mm
PCM 030403 B/VB055	3	4,5	3	PCM 121408 B	12	14	8
PCM 030403 E/BV055	3	4,5	3	PCM 121408 E	12	14	8
PCM 030405 B/VB055	3	4,5	5	PCM 121410 B	12	14	10
PCM 030405 E/VB055	3	4,5	5	PCM 121410 E	12	14	10
PCM 030406 B/VB055	3	4,5	6	PCM 121412 B	12	14	12
PCM 030406 E/VB 055	3	4,5	6	PCM 121412 E	12	14	12
PCM 040503 B/VB055	4	5,5	3	PCM 121415 B	12	14	15
PCM 040503 E/VB055	4	5,5	3	PCM 121415 E	12	14	15
PCM 040504 B/VB055	4	5,5	4	PCM 121420 B	12	14	20
PCM 040504 E/VB055	4	5,5	4	PCM 121420 E	12	14	20
PCM 040506 B/VB055	4	5,5	6	PCM 121425 B	12	14	25
PCM 040506 E/VB055	4	5,5	6	PCM 121425 E	12	14	25
PCM 040510 B/VB055	4	5,5	10	PCM 141610 B	14	16	10
PCM 040510 E/VB055	4	5,5	10	PCM 141610 E	14	16	10
PCM 050705 B	5	7	5	PCM 141612 B	14	16	12
PCM 050705 E	5	7	5	PCM 141612 E	14	16	12
PCM 050708 B	5	7	8	PCM 141615 B	14	16	15
PCM 050708 E	5	7	8	PCM 141615 E	14	16	15
PCM 050710 B	5	7	10	PCM 141620 B	14	16	20
PCM 050710 E	5	7	10	PCM 141620 E	14	16	20
PCM 060806 B	6	8	6	PCM 141625 B	14	16	25
PCM 060806 E	6	8	6	PCM 141625 E	14	16	25
PCM 060808 B	6	8	8	PCM 151710 B	15	17	10
PCM 060808 E	6	8	8	PCM 151710 E	15	17	10
PCM 060810 B	6	8	10	PCM 151712 B	15	17	12
PCM 060810 E	6	8	10	PCM 151712 E	15	17	12
PCM 081006 B	8	10	6	PCM 151715 B	15	17	15
PCM 081006 E	8	10	6	PCM 151715 E	15	17	15
PCM 081008 B	8	10	8	PCM 151720 B	15	17	20
PCM 081008 E	8	10	8	PCM 151720 E	15	17	20
PCM 081010 B	8	10	10	PCM 151725 B	15	17	25
PCM 081010 E	8	10	10	PCM 151725 E	15	17	25
PCM 081012 B	8	10	12	PCM 161810 B	16	18	10
PCM 081012 E	8	10	12	PCM 161810 E	16	18	10
PCM 101208 B	10	12	8	PCM 161812 B	16	18	12
PCM 101208 E	10	12	8	PCM 161812 E	16	18	12
PCM 101210 B	10	12	10	PCM 161815 B	16	18	15
PCM 101210 E	10	12	10	PCM 161815 E	16	18	15
PCM 101212 B	10	12	12	PCM 161820 E	16	18	20
PCM 101212 E	10	12	12	PCM 161820 B	16	18	20
PCM 101215 B	10	12	15	PCM 161825 B	16	18	25
PCM 101215 E	10	12	15	PCM 161825 E	16	18	25
PCM 101220 B	10	12	20	PCM 171920 E	17	19	20
PCM 101220 E	10	12	20				

Other dimensions available on request

Designation	d mm	D mm	B mm
PCM 182015 B	18	20	15
PCM 182015 E	18	20	15
PCM 182020 B	18	20	20
PCM 182020 E	18	20	20
PCM 182025 B	18	20	25
PCM 182025 E	18	20	25
PCM 202210 B	20	22	10
PCM 202210 E	20	22	10
PCM 202220 B	20	22	20
PCM 202220 E	20	22	20
PCM 202310 B	20	23	10
PCM 202310 E	20	23	10
PCM 202315 B	20	23	15
PCM 202315 E	20	23	15
PCM 202320 B	20	23	20
PCM 202320 E	20	23	20
PCM 202325 B	20	23	25
PCM 202325 E	20	23	25
PCM 202330 B	20	23	30
PCM 202330 E	20	23	30
PCM 222515 B	22	25	15
PCM 222515 E	22	25	15
PCM 222520 B	22	25	20
PCM 222520 E	22	25	20
PCM 222525 B	22	25	25
PCM 222525 E	22	25	25
PCM 222530 B	22	25	30
PCM 222530 E	22	25	30
PCM 242715 B	24	27	15
PCM 242715 E	24	27	15
PCM 242720 B	24	27	20
PCM 242720 E	24	27	20
PCM 242730 B	24	27	30
PCM 242730 E	24	27	30
PCM 252810 B	25	28	10
PCM 252810 E	25	28	10
PCM 252812 B	25	28	12
PCM 252812 E	25	28	12
PCM 252815 B	25	28	15
PCM 252815 E	25	28	15
PCM 252820 B	25	28	20
PCM 252820 E	25	28	20
PCM 252825 B	25	28	25
PCM 252825 E	25	28	25
PCM 252830 B	25	28	30
PCM 252830 E	25	28	30
PCM 252840 E	25	28	40
PCM 252850 E	25	28	50

Designation	d mm	D mm	B mm
PCM 283220 B	28	32	20
PCM 283220 E	28	32	20
PCM 283225 B	28	32	25
PCM 283225 E	28	32	25
PCM 283230 B	28	32	30
PCM 283230 E	28	32	30
PCM 303415 B	30	34	15
PCM 303415 E	30	34	15
PCM 303420 B	30	34	20
PCM 303420 E	30	34	20
PCM 303425 B	30	34	25
PCM 303425 E	30	34	25
PCM 303430 B	30	34	30
PCM 303430 E	30	34	30
PCM 303440 B	30	34	40
PCM 303440 E	30	34	40
PCM 323620 B	32	36	20
PCM 323620 E	32	36	20
PCM 323630 B	32	36	30
PCM 323630 E	32	36	30
PCM 323640 B	32	36	40
PCM 323640 E	32	36	40
PCM 3353920 E	35	39	20
PCM 3353930 E	35	39	30
PCM 3353940 E	35	39	40
PCM 3353950 E	35	39	50
PCM 353920 B	35	39	20
PCM 353930 B	35	39	30
PCM 353940 B	35	39	40
PCM 353950 B	35	39	50
PCM 374020 B	37	40	20
PCM 404420 B	40	44	20
PCM 404420 E	40	44	20
PCM 404430 B	40	44	30
PCM 404430 E	40	44	30
PCM 404440 B	40	44	40
PCM 404440 E	40	44	40
PCM 404450 B	40	44	50
PCM 404450 E	40	44	50

Other dimensions available on request



# SKF PTFE Composite – plain cylindrical bushings

## Construction of designation:

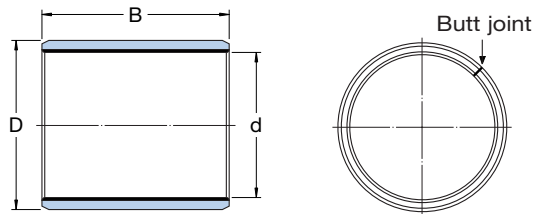
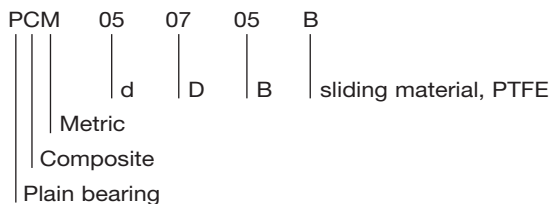

Designation	d mm	D mm	B mm	Designation	d mm	D mm	B mm
PCM 455020 B	45	50	20	PCM 758060 B	75	80	60
PCM 455020 E	45	50	20	PCM 758060 E	75	80	60
PCM 455030 B	45	50	30	PCM 758080 B	75	80	80
PCM 455030 E	45	50	30	PCM 758080 E	75	80	80
PCM 455040 B	45	50	40	PCM 808540 B	80	85	40
PCM 455040 E	45	50	40	PCM 808540 E	80	85	40
PCM 455050 B	45	50	50	PCM 808560 B	80	85	60
PCM 455050 E	45	50	50	PCM 808560 E	80	85	60
PCM 505520 B	50	55	20	PCM 8085100 B	80	85	100
PCM 505520 E	50	55	20	PCM 8085100 E	80	85	100
PCM 505530 E	50	55	30	PCM 859030 B	85	90	30
PCM 505530 B	50	55	30	PCM 859030 E	85	90	30
PCM 505540 B	50	55	40	PCM 859060 B	85	90	60
PCM 505540 E	50	55	40	PCM 859060 E	85	90	60
PCM 505560 B	50	55	60	PCM 909560 B	90	95	60
PCM 505560 E	50	55	60	PCM 909560 E	90	95	60
PCM 556030 B	55	60	30	PCM 9095100 B	90	95	100
PCM 556030 E	55	60	30	PCM 9095100 E	90	95	100
PCM 556040 B	55	60	40	PCM 9510060 B	95	100	60
PCM 556040 E	55	60	40	PCM 9510060 E	95	100	60
PCM 556060 B	55	60	60	PCM 95100100 B	95	100	100
PCM 556060 E	55	60	60	PCM 95100100 E	95	100	100
PCM 606520 B	60	65	20	PCM 10010560 B	100	105	60
PCM 606520 E	60	65	20	PCM 100105115 B	100	105	115
PCM 606530 B	60	65	30	PCM 11011560 B	110	115	60
PCM 606530 E	60	65	30	PCM 110115115 B	110	115	115
PCM 606540 B	60	65	40	PCM 12012560 B	120	125	60
PCM 606540 E	60	65	40	PCM 120125100 B	120	125	100
PCM 606560 B	60	65	60	PCM 130135100 B	130	135	100
PCM 606560 E	60	65	60	PCM 14014560 B	140	145	60
PCM 606570 B	60	65	70	PCM 140145100 B	140	145	100
PCM 606570 E	60	65	70	PCM 15015560 B	150	155	60
PCM 657030 B	65	70	30	PCM 15015580 B	150	155	80
PCM 657030 E	65	70	30	PCM 150155100 B	150	155	100
PCM 657050 B	65	70	50	PCM 160165100 B	160	165	100
PCM 657050 E	65	70	50	PCM 180185100 B	180	185	100
PCM 657070 B	65	70	70	PCM 200205100 B	200	205	100
PCM 657070 E	65	70	70				
PCM 707540 B	70	75	40				
PCM 707540 E	70	75	40				
PCM 707550 B	70	75	50				
PCM 707550 E	70	75	50				
PCM 707570 B	70	75	70				
PCM 707570 E	70	75	70				

# SKF PTFE Composite – flanged cylindrical bushings

## Construction of designation:

PCMF 06 08 04 B  

Flanged  
 Metric  
 Composite  
 Plain bearing

d D B sliding material, PTFE

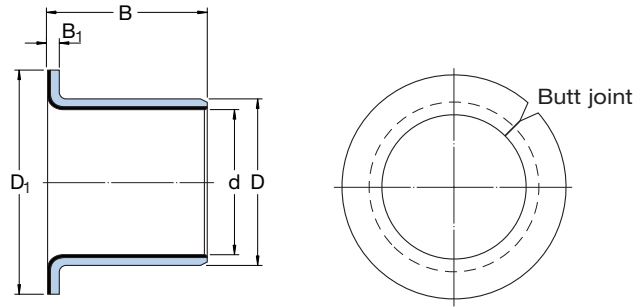

Designation	d mm	D mm	B mm	D <sub>1</sub> mm	B <sub>1</sub> mm
PCMF 060804 B	6	8	4	12	1
PCMF 060804 E	6	8	4	12	1
PCMF 060808 B	6	8	8	12	1
PCMF 060808 E	6	8	8	12	1
PCMF 081005.5 B	8	10	5,5	15	1
PCMF 081005.5 E	8	10	5,5	15	1
PCMF 081007.5 B	8	10	7,5	15	1
PCMF 081007.5 E	8	10	7,5	15	1
PCMF 081009.5 B	8	10	9,5	15	1
PCMF 081009.5 E	8	10	9,5	15	1
PCMF 101207 B	10	12	7	18	1
PCMF 101207 E	10	12	7	18	1
PCMF 101209 B	10	12	9	18	1
PCMF 101209 E	10	12	9	18	1
PCMF 101212 B	10	12	12	18	1
PCMF 101212 E	10	12	12	18	1
PCMF 101217 B	10	12	17	18	1
PCMF 101217 E	10	12	17	18	1
PCMF 121407 B	12	14	7	20	1
PCMF 121407 E	12	14	7	20	1
PCMF 121409 B	12	14	9	20	1
PCMF 121409 E	12	14	9	20	1
PCMF 121412 B	12	14	12	20	1
PCMF 121412 E	12	14	12	20	1
PCMF 121415 B	12	14	15	20	1
PCMF 121415 E	12	14	15	20	1
PCMF 121417 B	12	14	17	20	1
PCMF 121417 E	12	14	17	20	1
PCMF 141612 B	14	16	12	22	1
PCMF 141612 E	14	16	12	22	1
PCMF 141617 B	14	16	17	22	1
PCMF 141617 E	14	16	17	22	1
PCMF 151709 B	15	17	9	23	1
PCMF 151709 E	15	17	9	23	1
PCMF 151712 B	15	17	12	23	1
PCMF 151712 E	15	17	12	23	1
PCMF 151717 B	15	17	17	23	1
PCMF 151717 E	15	17	17	23	1
PCMF 161812 B	16	18	12	24	1
PCMF 161812 E	16	18	12	24	1
PCMF 161817 B	16	18	17	24	1
PCMF 161817 E	16	18	17	24	1

Designation	d mm	D mm	B mm	D <sub>1</sub> mm	B <sub>1</sub> mm
PCMF 182012 B	18	20	12	26	1
PCMF 182012 E	18	20	12	26	1
PCMF 182017 B	18	20	17	26	1
PCMF 182017 E	18	20	17	26	1
PCMF 182022 B	18	20	22	26	1
PCMF 182022 E	18	20	22	26	1
PCMF 202311.5 B	20	23	11,5	30	1,5
PCMF 202311.5 E	20	23	11,5	30	1,5
PCMF 202315 B	20	23	15	30	1,5
PCMF 202315 E	20	23	15	30	1,5
PCMF 202316.5 B	20	23	16,5	30	1,5
PCMF 202316.5 E	20	23	16,5	30	1,5
PCMF 202321.5 B	20	23	21,5	30	1,5
PCMF 202321.5 E	20	23	21,5	30	1,5
PCMF 252811.5 B	25	28	11,5	35	1,5
PCMF 252811.5 E	25	28	11,5	35	1,5
PCMF 252816.5 B	25	28	16,5	35	1,5
PCMF 252816.5 E	25	28	16,5	35	1,5
PCMF 252821.5 B	25	28	21,5	35	1,5
PCMF 252821.5 E	25	28	21,5	35	1,5
PCMF 303416 B	30	34	16	42	2
PCMF 303416 E	30	34	16	42	2
PCMF 303426 B	30	34	26	42	2
PCMF 303426 E	30	34	26	42	2
PCMF 353916 B	35	39	16	47	2
PCMF 353916 E	35	39	16	47	2
PCMF 353926 B	35	39	26	47	2
PCMF 353926 E	35	39	26	47	2

Other dimensions available on request

# SKF PTFE Composite – thrust washers

## Construction of designation:

PCMW 10 20 01,5 B  
 | | | | |  
 | | | | | sliding material, PTFE  
 | | | | | Thrust washer  
 | | | | | Metric  
 | | | | | Composite  
 | | | | | Plain bearing

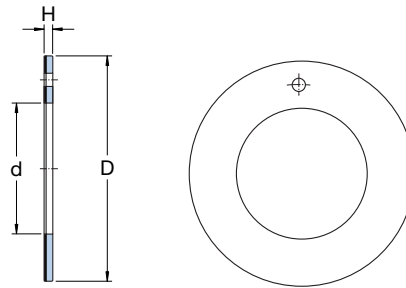

Designation	d mm	D mm	H mm
<b>PCMW 102001.5 B</b>	10	20	1,5
<b>PCMW 122401.5 B</b>	12	24	1,5
<b>PCMW 142601.5 B</b>	14	26	1,5
<b>PCMW 183201.5 B</b>	18	32	1,5
<b>PCMW 203601.5 B</b>	20	36	1,5
<b>PCMW 223801.5 B</b>	22	38	1,5

Designation	d mm	D mm	H mm
<b>PCMW 264401.5 B</b>	26	44	1,5
<b>PCMW 284801.5 B</b>	28	48	1,5
<b>PCMW 325401.5 B</b>	32	54	1,5
<b>PCMW 386201.5 B</b>	38	62	1,5
<b>PCMW 426601.5 B</b>	42	66	1,5
<b>PCMW 527802 B</b>	52	78	2

# SKF PTFE Composite – strips

## Construction of designation:

PCMS 100 500 0,75 B  
 | B | L | H | sliding material, PTFE  
 | Strip  
 | Metric  
 | Composite  
 | Plain bearing

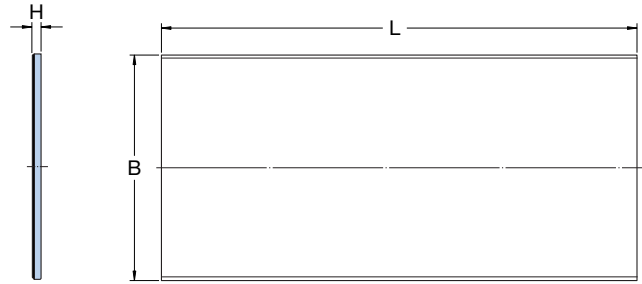

Designation	B mm	L mm	H mm
<b>PCMS 1005000.75 B</b>	100	500	0,75
<b>PCMS 1005001.0 B</b>	100	500	1
<b>PCMS 1005001.50 B</b>	100	500	1,5

Designation	B mm	L mm	H mm
<b>PCMS 1005002.0 B</b>	100	500	2
<b>PCMS 1005002.50 B</b>	100	500	2,5
<b>PCMS 1005003.06 B</b>	100	500	3,06

Other dimensions available on request



# SKF POM Composite – plain cylindrical bushings

## Construction of designation:

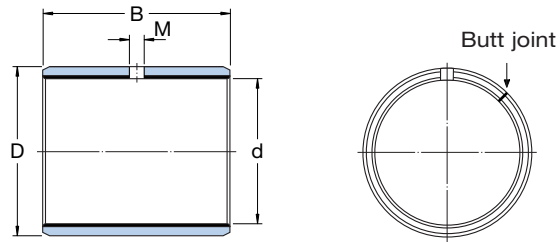
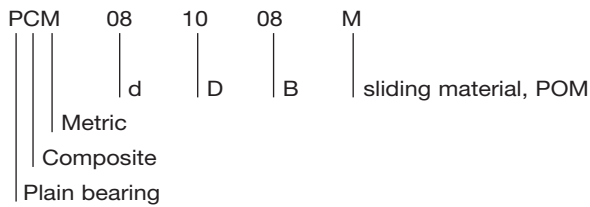

Designation	d mm	D mm	B mm	M mm	Designation	d mm	D mm	B mm	M mm
PCM 081008 M	8	10	8	–	PCM 353920 M	35	39	20	4
PCM 081010 M	8	10	10	–	PCM 353930 M	35	39	30	4
PCM 081012 M	8	10	12	–	PCM 353950 M	35	39	50	4
PCM 101210 M	10	12	10	–	PCM 404420 M	40	44	20	4
PCM 101212 M	10	12	12	3	PCM 404430 M	40	44	30	4
PCM 101215 M	10	12	15	3	PCM 404440 M	40	44	40	4
PCM 101220 M	10	12	20	3	PCM 404450 M	40	44	50	4
PCM 121410 M	12	14	10	3	PCM 455030 M	45	50	30	5
PCM 121415 M	12	14	15	3	PCM 455040 M	45	50	40	5
PCM 121420 M	12	14	20	3	PCM 455050 M	45	50	50	5
PCM 141620 M	14	16	20	3	PCM 505530 M	50	55	30	5
PCM 141625 M	14	16	25	3	PCM 505540 M	50	55	40	5
PCM 151715 M	15	17	15	3	PCM 505560 M	50	55	60	5
PCM 161815 M	16	18	15	3	PCM 556040 M	55	60	40	6
PCM 161820 M	16	18	20	3	PCM 606530 M	60	65	30	6
PCM 161825 M	16	18	25	3	PCM 606540 M	60	65	40	6
PCM 182015 M	18	20	15	3	PCM 606560 M	60	65	60	6
PCM 182020 M	18	20	20	3	PCM 606570 M	60	65	70	6
PCM 182025 M	18	20	25	3	PCM 657050 M	65	70	50	6
PCM 202310 M	20	23	10	3	PCM 657070 M	65	70	70	6
PCM 202315 M	20	23	15	3	PCM 707540 M	70	75	40	6
PCM 202320 M	20	23	20	3	PCM 707550 M	70	75	50	6
PCM 202325 M	20	23	25	3	PCM 707570 M	70	75	70	6
PCM 202330 M	20	23	30	3	PCM 758040 M	75	80	40	6
PCM 222515 M	22	25	15	3	PCM 758060 M	75	80	60	6
PCM 222520 M	22	25	20	3	PCM 808540 M	80	85	40	6
PCM 222525 M	22	25	25	3	PCM 808560 M	80	85	60	6
PCM 252815 M	25	28	15	4	PCM 808580 M	80	85	80	6
PCM 252820 M	25	28	20	4	PCM 8085100 M	80	85	100	6
PCM 252825 M	25	28	25	4	PCM 859060 M	85	90	60	6
PCM 252830 M	25	28	30	4	PCM 909560 M	90	95	60	6
PCM 283220 M	28	32	20	4	PCM 9095100 M	90	95	100	6
PCM 283225 M	28	32	25	4	PCM 9510060 M	95	100	60	6
PCM 283230 M	28	32	30	4	PCM 10010560 M	100	105	60	6
PCM 303420 M	30	34	20	4	PCM 10010580 M	100	105	80	6
PCM 303430 M	30	34	30	4	PCM 100105115 M	100	105	115	6
PCM 303440 M	30	34	40	4					
PCM 323630 M	32	36	30	4					

Other dimensions available on request

<b>Designation</b>	<b>d mm</b>	<b>D mm</b>	<b>B mm</b>	<b>M mm</b>
<b>PCM 11011560 M</b>	110	115	60	8
<b>PCM 110115115 M</b>	110	115	115	8
<b>PCM 12012560 M</b>	120	125	60	8
<b>PCM 120125100 M</b>	120	125	100	8
<b>PCM 130135100 M</b>	130	135	100	8
<b>PCM 14014560 M</b>	140	145	60	8
<b>PCM 15015560 M</b>	150	155	60	8

Other dimensions available on request

# SKF POM Composite – thrust washers

**Construction of designation:**

PCMW 14 26 01,5 M  
 | | | | d | D | B | sliding material, POM  
 | | | | Thrust washer  
 | | | | Metric  
 | | | | Composite  
 | | | Plain bearing

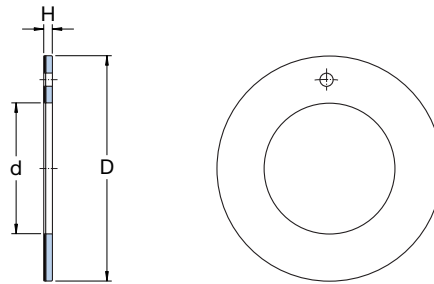

Designation	d mm	D mm	H mm
<b>PCMW 142601.5 M</b>	14	26	1,5
<b>PCMW 203601.5 M</b>	20	36	1,5
<b>PCMW 264401.5 M</b>	26	44	1,5

Designation	d mm	D mm	H mm
<b>PCMW 325401.5 M</b>	32	54	1,5
<b>PCMW 426601.5 M</b>	42	66	1,5
<b>PCMW 527802 M</b>	52	78	2

# SKF POM Composite – strips

## Construction of designation:

PCMS 100 500 1,0 M  
 | B | L | H | sliding material, POM  
 | Strip  
 | Metric  
 | Composite  
 | Plain bearing

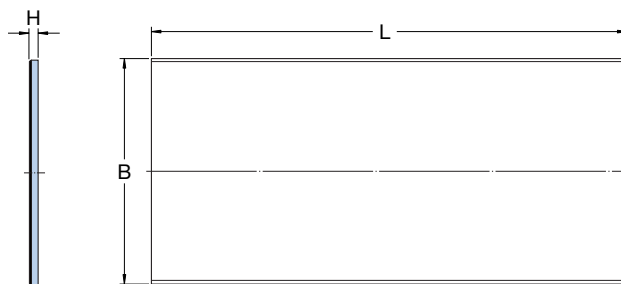

Designation	B mm	L mm	H mm
<b>PCMS 1005001.0 M</b>	100	500	1
<b>PCMS 1005001.50 M</b>	100	500	1,5
<b>PCMS 1005002.0 M</b>	100	500	2

Designation	B mm	L mm	H mm
<b>PCMS 1005002.50 M</b>	100	500	2,5
<b>PCMS 1005003.06 M</b>	100	500	3,06



# SKF Stainless Backed Composite – plain cylindrical bushings

## Construction of designation:

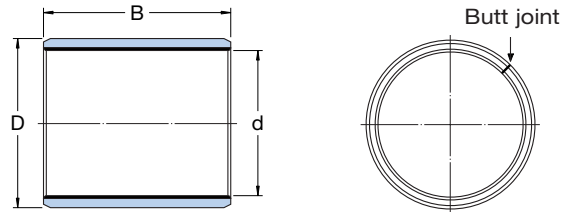
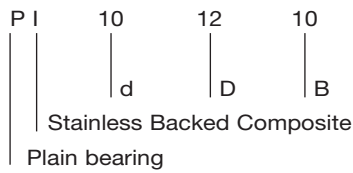

Designation	d mm	D mm	B mm	Designation	d mm	D mm	B mm
PI 101210	10	12	10	PI 404510	40	45	10
PI 101215	10	12	15	PI 404515	40	45	15
PI 121410	12	14	10	PI 404520	40	45	20
PI 121415	12	14	15	PI 404525	40	45	25
PI 141615	14	16	15	PI 404540	40	45	40
PI 141620	14	16	20	PI 455015	45	50	15
PI 151710	15	17	10	PI 455020	45	50	20
PI 151720	15	17	20	PI 455025	45	50	25
PI 161809	16	18	9	PI 455030	45	50	30
PI 161815	16	18	15	PI 455035	45	50	35
PI 161820	16	18	20	PI 455040	45	50	40
PI 182015	18	20	15	PI 455050	45	50	50
PI 182020	18	20	20	PI 455060	45	50	60
PI 202315	20	23	15	PI 505520	50	55	20
PI 202320	20	23	20	PI 505525	50	55	25
PI 202325	20	23	25	PI 505530	50	55	30
PI 202510	20	25	10	PI 505540	50	55	40
PI 202515	20	25	15	PI 505560	50	55	60
PI 222510	22	25	10	PI 556015	55	60	15
PI 222515	22	25	15	PI 556025	55	60	25
PI 222520	22	25	20	PI 556030	55	60	30
PI 252810	25	28	10	PI 556040	55	60	40
PI 252815	25	28	15	PI 556050	55	60	50
PI 252820	25	28	20	PI 556060	55	60	60
PI 252825	25	28	25	PI 606520	60	65	20
PI 252840	25	28	40	PI 606530	60	65	30
PI 303415	30	34	15	PI 606540	60	65	40
PI 303420	30	34	20	PI 606550	60	65	50
PI 303425	30	34	25	PI 606560	60	65	60
PI 303440	30	34	40	PI 657040	65	70	40
PI 353910	35	39	10	PI 657060	65	70	60
PI 353915	35	39	15	PI 707525	70	75	25
PI 353920	35	39	20	PI 707530	70	75	30
PI 353925	35	39	25	PI 707540	70	75	40
PI 353930	35	39	30	PI 707550	70	75	50
PI 353940	35	39	40	PI 707560	70	75	60
				PI 758030	75	80	30
				PI 758040	75	80	40
				PI 758050	75	80	50
				PI 758060	75	80	60

Other dimensions available on request

<b>Designation</b>	<b>d mm</b>	<b>D mm</b>	<b>B mm</b>
<b>PI 808520</b>	80	85	20
<b>PI 808540</b>	80	85	40
<b>PI 808550</b>	80	85	50
<b>PI 808560</b>	80	85	60
<b>PI 808590</b>	80	85	90
<b>PI 909540</b>	90	95	40
<b>PI 909550</b>	90	95	50
<b>PI 909560</b>	90	95	60
<b>PI 909570</b>	90	95	70
<b>PI 909590</b>	90	95	90
<b>PI 9510060</b>	95	100	60
<b>PI 9510070</b>	95	100	70
<b>PI 9510090</b>	95	100	90
<b>PI 10010560</b>	100	105	60
<b>PI 10010590</b>	100	105	90
<b>PI 11011560</b>	110	115	60
<b>PI 12012560</b>	120	125	60
<b>PI 13013560</b>	130	135	60
<b>PI 14014590</b>	140	145	90
<b>PI 15015560</b>	150	155	60

Other dimensions available on request

# SKF PTFE Polyamide – plain cylindrical bushings

**Construction of designation:**

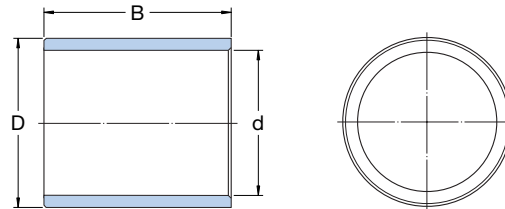
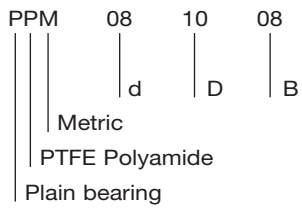

Designation	d mm	D mm	B mm
<b>PPM 081008</b>	8	10	8
<b>PPM 081010</b>	8	10	10
<b>PPM 101210</b>	10	12	10
<b>PPM 101212</b>	10	12	12
<b>PPM 101215</b>	10	12	15
<b>PPM 121410</b>	12	14	10
<b>PPM 121412</b>	12	14	12
<b>PPM 121415</b>	12	14	15
<b>PPM 141615</b>	14	16	15
<b>PPM 141620</b>	14	16	20

Designation	d mm	D mm	B mm
<b>PPM 151715</b>	15	17	15
<b>PPM 151720</b>	15	17	20
<b>PPM 161815</b>	16	18	15
<b>PPM 161820</b>	16	18	20
<b>PPM 202315</b>	20	23	15
<b>PPM 202320</b>	20	23	20
<b>PPM 252815</b>	25	28	15
<b>PPM 252820</b>	25	28	20
<b>PPM 303420</b>	30	34	20
<b>PPM 303430</b>	30	34	30

Other dimensions available on request

# SKF PTFE Polyamide – flanged cylindrical bushings

### Construction of designation:

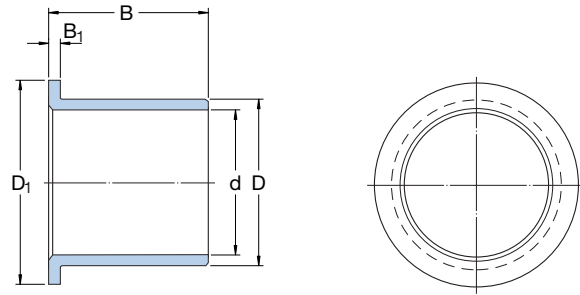
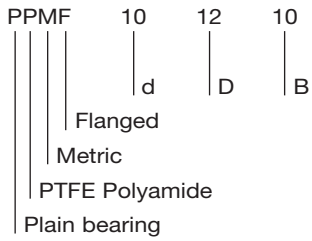

Designation	d mm	D mm	B mm	D <sub>1</sub> mm	B <sub>1</sub> mm
<b>PPMF 101207</b>	10	12	7	18	1
<b>PPMF 101212</b>	10	12	12	18	1
<b>PPMF 121409</b>	12	14	9	20	1
<b>PPMF 121412</b>	12	14	12	20	1
<b>PPMF 141612</b>	14	16	12	22	1
<b>PPMF 141617</b>	14	16	17	22	1

Designation	d mm	D mm	B mm	D <sub>1</sub> mm	B <sub>1</sub> mm
<b>PPMF 151712</b>	15	17	12	23	1
<b>PPMF 151717</b>	15	17	17	23	1
<b>PPMF 161817</b>	16	18	17	24	1
<b>PPMF 202311.5</b>	20	23	11,5	30	1,5
<b>PPMF 202321.5</b>	20	23	21,5	30	1,5
<b>PPMF 252811.5</b>	25	28	11,5	35	1,5
<b>PPMF 252821.5</b>	25	28	21,5	35	1,5

# SKF Filament Wound – plain cylindrical bushings

## Construction of designation:

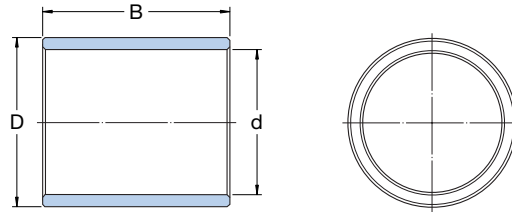
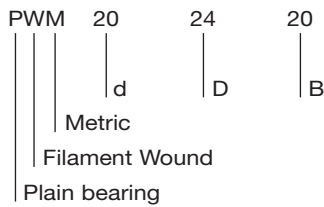

Designation	d mm	D mm	B mm
PWM 202415	20	24	15
PWM 202420	20	24	20
PWM 202430	20	24	30
PWM 253020	25	30	20
PWM 253030	25	30	30
PWM 253040	25	30	40
PWM 303620	30	36	20
PWM 303630	30	36	30
PWM 303640	30	36	40
PWM 354130	35	41	30
PWM 354140	35	41	40
PWM 354150	35	41	50
PWM 404830	40	48	30
PWM 404840	40	48	40
PWM 404860	40	48	60
PWM 455330	45	53	30
PWM 455340	45	53	40
PWM 455360	45	53	60
PWM 505840	50	58	40
PWM 505850	50	58	50
PWM 505860	50	58	60
PWM 556340	55	63	40
PWM 556350	55	63	50
PWM 556370	55	63	70
PWM 607040	60	70	40
PWM 607060	60	70	60
PWM 607080	60	70	80
PWM 657550	65	75	50
PWM 657560	65	75	60
PWM 657580	65	75	80
PWM 708050	70	80	50
PWM 708070	70	80	70
PWM 708090	70	80	90
PWM 758550	75	85	50
PWM 758570	75	85	70
PWM 758590	75	85	90
PWM 809060	80	90	60
PWM 809080	80	90	80
PWM 8090100	80	90	100

Designation	d mm	D mm	B mm
PWM 859560	85	95	60
PMW 859580	85	95	80
PWM 8595100	85	95	100
PWM 9010560	90	105	60
PWM 9010580	90	105	80
PWM 90105120	90	105	120
PWM 9511060	95	110	60
PWM 95110100	95	110	100
PWM 95110120	95	110	120
PWM 10011580	100	115	80
PWM 100115100	100	115	100
PWM 100115120	100	115	120
PWM 10512080	105	120	80
PWM 105120100	105	120	100
PWM 105120120	105	120	120
PWM 11012580	110	125	80
PWM 110125100	110	125	100
PWM 110125120	110	125	120
PWM 120135100	120	135	100
PWM 120135120	120	135	120
PWM 120135150	120	135	150
PWM 130145100	130	145	100
PWM 130145120	130	145	120
PWM 130145150	130	145	150
PWM 140155100	140	155	100
PWM 140155150	140	155	150
PWM 140155180	140	155	180
PWM 150165120	150	165	120
PWM 150165150	150	165	150
PWM 150165180	150	165	180
PWM 160180120	160	180	120
PWM 160180150	160	180	150
PWM 160180180	160	180	180
PWM 170190120	170	190	120
PWM 170190180	170	190	180
PWM 170190200	170	190	200
PWM 180200150	180	200	150
PWM 180200180	180	200	180
PWM 180200250	180	200	250

Other dimensions available on request

---

<b>Designation</b>	<b>d mm</b>	<b>D mm</b>	<b>B mm</b>
<b>PWM 190210150</b>	190	210	150
<b>PWM 190210180</b>	190	210	180
<b>PWM 190210250</b>	190	210	250
<b>PWM 200220180</b>	200	220	180
<b>PWM 200220200</b>	200	220	200
<b>PWM 200220250</b>	200	220	250

---

Other dimensions available on request



® SKF is registered trademark of the SKF Group.

© Copyright SKF 2003

The contents of this publication are the copyright of the publisher and may not be reproduced (even extracts) unless permission is granted. Every care has been taken to ensure the accuracy of the information contained in this publication but no liability can be accepted for any loss or damage whether direct, indirect or consequential arising out of the use of the information contained herein.

Publication **4741/I E**

Printed in Estonia on environmentally friendly, chlorine-free paper (Multiart Silk) by UP Print.